

# Digital HD Video Camera Recorder

**Handbook**

Table of contents

Operation Search

Settings Search

Index

**GB**

# How to use this handbook

Click on a button on the right to jump to the corresponding page.  
This is convenient when searching for a function you want to view.

**SONY** 4-632-707-11(1)

Digital HD Video Camera Recorder

Handbook

- Table of contents → Search for information by function.
- Operation Search → Search for information by operation.
- Settings Search → Search for information in a listing of Settings items.
- Index → Search for information by keyword.

- Table of contents
- Operation Search
- Settings Search
- Index

## Marks and notations used in this handbook

**Flip** Setting display [SETUP] → [FLIP]

You can record the image upside down. This function is useful when the camera is attached upside down.  
To make the setting, select [SETUP] first.

- 1 Press the NEXT button to display [SETUP], then press the ENTER button.
- 2 Press the NEXT button to display [FLIP] (Flip), then press the ENTER button.
- 3 Press the NEXT button to select the setting, then press the ENTER button.

<input checked="" type="checkbox"/>	Flips the image vertically and swaps the left and right sound channels.
<input type="checkbox"/>	Returns to the [FLIP] menu.
<input type="checkbox"/>	GMT+0 Sets the region in which you use the camera. (Regions are defined by time difference from Greenwich Mean Time (GMT)).

**Notes**

- When you set the GPS log to [ON], the camera adjusts date, time and region automatically during shooting mode.

**Setting the region**

You can set the clock to the local time of a country you visit by selecting the region. Regions are defined by time difference from Greenwich Mean Time (GMT). Refer also to "World time difference" (page 75).

- ✓ The default setting is indicated by ✓.
- Notes Indicates cautions and limitations relevant to the correct operation of the camera.
- 💡 Indicates information that is useful to know.

# Notes on using the camera

## About the displayed language

The display panel displays only English, French and Brazilian Portuguese. Other languages are not available.

## Notes on recording/playback and connection

- Before you start recording, make a trial recording to make sure that the camera is working correctly.
- To play back images, connect the camera to another device with a micro HDMI cable (sold separately).
- The camera is neither dust-proof nor water-proof. Read “Precautions” (page 76) before operating the camera.
- Avoid exposing the camera to moisture while the connector cover or battery pack/memory card cover is open. If the inside of the camera becomes damp, a malfunction may occur. In some cases, the camera cannot be repaired.
- Do not aim the camera at the sun or other bright light. It may cause malfunctions.
- Do not use the camera near a location that generates strong radio waves or emits radiation. Otherwise, the camera may not properly record or play back images.
- Using the camera in sandy or dusty locations may cause malfunctions.
- If moisture condensation occurs, remove it before using the camera (page 76).
- Do not shake or strike the camera. It may cause a malfunction and you may not be able to record images. Furthermore, a memory card may become unusable or image data may be damaged.
- When connecting the camera to another device with a cable, be sure to insert the connector plug in the correct way. Pushing the plug forcibly into the terminal will damage the terminal and may result in a malfunction of the camera.
- Playback of movies other than those shot, edited or composed on this camera is not guaranteed.
- When you switch between NTSC/PAL, the setting values that can be selected in the Image Quality Setting Mode change accordingly. Settings values for both [NTSC] and [PAL] are shown in this manual.

## On camera's temperature

The camera may get warm due to continuous use, but it is not a malfunction.

## On the overheat protection

Depending on the camera and battery temperature, you may be unable to record movies or the power may turn off automatically to protect the camera. A message will be displayed on the display panel before the power turns off or you can no longer record movies.

## Notes on the battery pack

- Charge the battery pack before using for the first time.
- You can charge the battery pack even if it is not completely discharged. In addition, even if the battery pack is not fully charged, you can use the partially charged capacity of the battery pack as is.
- For details on the battery packs, see page 74.

## Notes on the display panel and lens

- Exposing the display panel or the lens to direct sunlight for long periods may cause malfunctions. Be careful when placing the camera near a window or outdoors.
- Do not press against the display panel. It may cause a malfunction.

## On image data compatibility

- This camera supports "MP4 format" as movie file format. However, it is not guaranteed that all MP4 compliant devices can play back images recorded with this camera.
- The camera conforms with DCF (Design rule for Camera File system) universal standard established by JEITA (Japan Electronics and Information Technology Industries Association).

## Warning on copyright

Television programs, films, videotapes, and other materials may be copyrighted. Unauthorized recording of such materials may be contrary to the provisions of the copyright laws.

## No compensation for damaged content or recording failure

Sony cannot compensate for failure to record or loss or damage of recorded content due to a malfunction of the camera or memory card, etc.

## The illustrations and images used in this handbook

- The images used as examples in this handbook are reproduced images, and are not actual images shot using the camera.
- In this manual, Memory Stick Micro™ media and microSD memory card are referred to as “memory card.”
- Design and specifications are subject to change without notice.

## Notes on playing back on other devices

- The camera is compatible with MPEG-4 AVC/H.264 Main Profile for HD (high definition) image quality recording. Therefore, you cannot play back images recorded with HD (high definition) image quality on the camera with the devices which are not compatible with the MPEG-4 AVC/H.264.
- Movies recorded using this camera may not play back normally on devices other than this camera. Also, movies recorded on other devices may not play back properly on this camera.

## On wireless network function

- The wireless network function built into this camera has been confirmed to conform with Wi-Fi specifications set forth by the Wi-Fi Alliance (WFA).
- Depending on the region, access to a wireless LAN may not be available, may require a separate service charge, or communications may be blocked or suffer from intermittent outages. For details, check your wireless LAN administrator and/or service provider.
- Sony makes no guarantees whatsoever in the provision of a network service. Sony bears absolutely no responsibility for damages that may arise from the use of a network service even in the case of claims made by a third-party.
- We assume no responsibility whatsoever for any damage caused by unauthorized access to, or unauthorized use of, destinations loaded on the camera, resulting from loss or theft.

## About the security on using Wireless LAN products

It is important to set security when using the wireless network function. Sony makes no guarantees and is not responsible for any damage resulting from having inadequate security or using the wireless network function.

## ZEISS lens

The camera is equipped with a ZEISS lens which is capable of reproducing sharp images with excellent contrast.

The lens for the camera has been produced under a quality assurance system certified by Carl Zeiss in accordance with the quality standards of Carl Zeiss in Germany.

## On GPS-compatible devices

- Use GPS in accordance with regulations of countries and regions where you use it.
- If you do not record the location information, set the GPS log to [OFF] (page 35).
- If you take images with the GPS log set to [ON], and upload those images to the internet, the shooting location may be available to third parties. To prevent this, set the GPS log to [OFF] before shooting (page 35).

## On splash-proof

The camera body has IPX4 splash-proof performance (based on our tests).

- This camera is protected from water splashed from any direction. However, it is not protected against pressurized water such as from a shower or tap.
- This camera is not splash-proof when a USB cable or HDMI cable is connected.
- Splash-proof performance may be lost if the camera is subjected to a strong shock, such as being dropped. We recommend the camera be inspected at your nearest Sony dealer (chargeable).
- Failure caused from incorrect use is not covered by the limited warranty.
  - Do not use the camera in water (the camera is not water-proof).
  - Firmly close the connector cover and battery pack/memory card cover. (If the cover is not fully closed, water may leak inside the camera. Do not open/close the cover when your hands are wet).

# Table of contents

---

## Notes on using the camera

How to use this handbook .....	2
Notes on using the camera .....	3
Operation Search .....	8
Settings Search .....	9
Identifying parts .....	11

---

## Getting started

Checking the bundled items .....	12
Inserting the battery pack .....	13
Inserting a memory card .....	16
Date & Time Setting .....	18
Daylight Saving Time (Summer Time) Setting ....	20
Image Quality Setting Mode .....	21
SteadyShot .....	23
Flip .....	24
Scene .....	25
Interval Photo Recording .....	26
Color Setting .....	27
XAVC S .....	28
Time Code/User Bit .....	29
IR-Remote Controller .....	31
Configuration Settings .....	32
Wi-Fi Remote Control .....	33
Copy .....	34
GPS Log .....	35
Airplane Mode .....	37
USB Power Supply .....	38
Auto Power Off .....	39
Beep .....	40
Language Setting .....	41
Switching NTSC/PAL .....	42

Resetting the Settings .....	43
Format .....	44
Using accessories .....	45

---

## Shooting

Shooting .....	52
----------------	----

---

## Viewing

Viewing images on a TV .....	54
------------------------------	----

---

## Wireless Network (Wi-Fi)

Preparation for connecting to your smartphone .....	56
Connecting to your smartphone .....	57
Connecting with the Live-View Remote .....	61

---

## Computer

Useful functions when connecting the camera to your computer .....	63
Preparing a computer .....	64

---

## Troubleshooting

Troubleshooting .....	66
Warning indicators and messages .....	70

---

## Others

Recordable time .....	72
Battery pack .....	74
Using the camera abroad.....	75
Precautions .....	76
Specifications .....	78

---

## Index

Index .....	81
-------------	----

# Operation Search

Shooting movies and photos	Shooting.....	52
Shooting high bit rate images	XAVC S.....	28
Changing the movie file size	Image Quality Setting Mode.....	21
Recording the location information	GPS Log.....	35
Deleting images	Format.....	44
Changing the date, time and region	Date & Time Setting.....	18
Initializing settings	Resetting the Settings.....	43
Viewing on TVs	Viewing images on a TV.....	54
Operating using a smartphone or tablet	Preparation for connecting to your smartphone.....	56
	Connecting to your smartphone.....	57
Copying images to a smartphone from the camera	Copy.....	34
Operating using a Live-View Remote	Connecting with the Live-View Remote.....	61

Table of contents

Operation Search

Settings Search

Index



# Settings Search

## Setting items

Click each item to jump to the corresponding page.

### List of modes

Display	Modes
MOVIE	Movie Mode
PHOTO	Photo Mode
INTVL	Interval Photo Recording Mode
VMODE	Image Quality Setting Mode
SETUP	Setup Mode
PLAY	Play Mode
PwOFF	Power off

### Items you can set in SETUP

Display	Items
STEDY	SteadyShot
FLIP	Flip
SCENE	Scene
LAPSE	Interval Photo Recording
COLOR	Color Setting
PRO	XAVC S™
TC/UB	Time Code/User Bit
IR-RC	IR-Remote Controller
CONFIG	Configuration Settings

### Items you can set in CONFIG

Display	Items
Wi-Fi	Wi-Fi Remote Control
GPS	GPS Log
PLANE	Airplane Mode
USBPw	USB Power Supply
A.OFF	Auto Power Off
BEEP	Beep
DATE	Date & Time Setting
DST	Daylight Saving Time (Summer Time) Setting
LANG	Language Setting
V.SYS	Switching NTSC/PAL
RESET	Resetting the Settings
FORMT	Format

### Notes

- The display panel displays only English, French and Brazilian Portuguese. Other languages are not available.

# How to set items

You can set items using the following 3 buttons on the camera.

**NEXT\***: Goes to the next menu

**PREV\***: Goes to the previous menu

**ENTER**: Executes the menu

\* Both NEXT and PREV buttons are used to change the menu.

In this manual, we usually use the NEXT button for description. When using only the PREV button, we describe it as the PREV button.

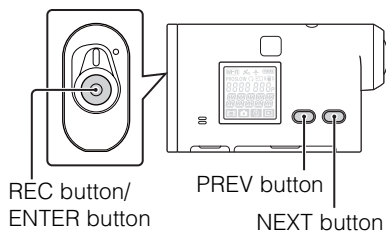

## 1 Press the NEXT or PREV button to turn on the power.

To power off, select [PwOFF] and press the ENTER button.

## 2 Press the NEXT button to display [SETUP], then press the ENTER button.

## 3 Press the NEXT button to display the setting item, then press the ENTER button.

To return to the [SETUP] menu, select [BACK] and press the ENTER button.

Table of contents



Operation Search

Settings Search

Index

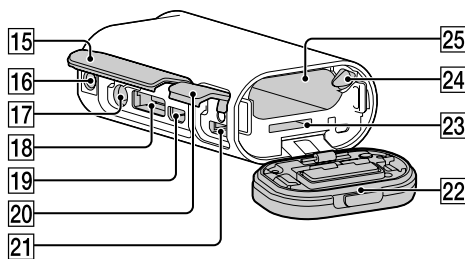
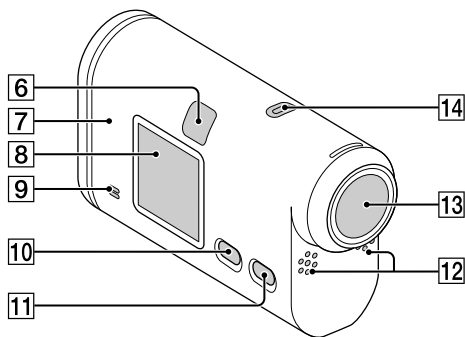
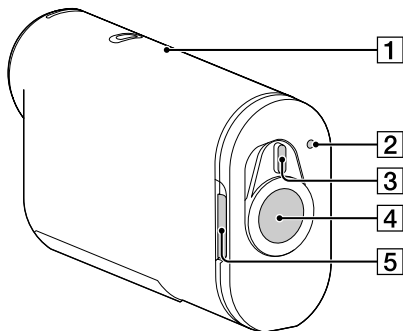
# Identifying parts



- 1 GPS sensor
- 2 REC/access/CHG (Charge) lamp\*<sup>1</sup>
- 3 REC HOLD (lock) switch\*<sup>2</sup>
- 4 REC (Movie/Photo) button  
ENTER (Menu execute) button
- 5 Lock lever
- 6 IR remote receiver
- 7  (N Mark)\*<sup>3</sup>
- 8 Display panel
- 9 Speaker
- 10 PREV button
- 11 NEXT button
- 12 Microphones
- 13 Lens
- 14 REC lamp
- 15 Connector cover
- 16 Tripod adaptor attachment hole
- 17  (Mic) jack\*<sup>4</sup>
- 18 Expansion connector\*<sup>5</sup>
- 19 HDMI OUT jack
- 20 Connector cover (USB)
- 21 Multi/Micro USB Terminal\*<sup>6</sup>
- 22 Battery pack/memory card cover
- 23 Memory card insertion slot
- 24 Battery ejection lever
- 25 Battery insertion slot

\*<sup>1</sup> The lamp lights in red while recording movies/ accessing recording media, or in amber during CHG (Charge).

\*<sup>2</sup> Used to prevent accidental operation. Slide in the direction of the arrow marked on the camera to lock the REC button. Slide in the opposite direction to release.

\*<sup>3</sup> Touch the mark when you connect the camera to a smartphone equipped with the NFC function.

NFC (Near Field Communication) is an international standard of the short-range wireless communication technology.

\*<sup>4</sup> When an external microphone (sold separately) is connected, audio cannot be recorded through the built-in microphone.

\*<sup>5</sup> Used to connect accessories.

\*<sup>6</sup> Supports Micro USB compatible devices.

# Checking the bundled items

Make sure that you have following bundled items.

The number in parentheses indicates the quantity of that item bundled.

- Camera (1)
- Micro USB cable (1)

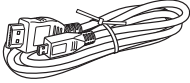

- Rechargeable battery pack (NP-BX1) (1)



- Waterproof Case (SPK-AS2) (1)

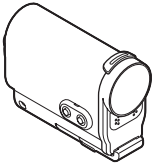

- Adhesive Mount (VCT-AM1) Attachment Buckle (1)

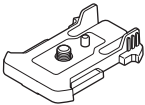

Flat Adhesive Mount (1)

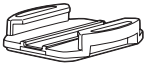

Curved Adhesive Mount (1)

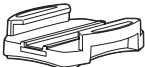

- Tripod Adaptor (1)

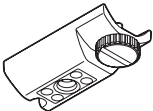

- Handbook (this manual)  
Included in the internal memory of this camera.
- Set of printed documentation

# Inserting the battery pack

- 1 Slide the lock lever until the yellow mark can be seen, then open the cover.

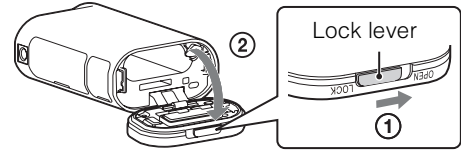

- 2 Insert the battery pack.

Make sure the direction of the battery pack is correct, then insert it pushing against the battery ejection lever, until the lever locks.

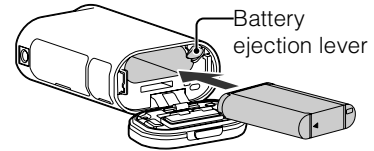

- 3 Close the cover.

Close the cover properly, so as the yellow mark on the lock lever is not visible.

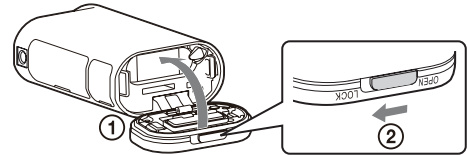

## To remove the battery pack

Open the cover and slide the battery ejection lever, then remove the battery pack.

## To set Auto Power Off function

Select [A.OFF] from the [SETUP] → [CONFIG] screen, then set the Auto Power Off function. The default setting is [60sec]. Change the setting as necessary. For details, see “Auto Power Off” (page 39).

# Charging the battery pack

## 1 Turn off the power of the camera.

Charging is not possible when the camera is turned on.

## 2 Connect the camera to the computer that is turned on with the micro USB cable (supplied).

The REC/access/CHG (Charge) lamp lights in amber.

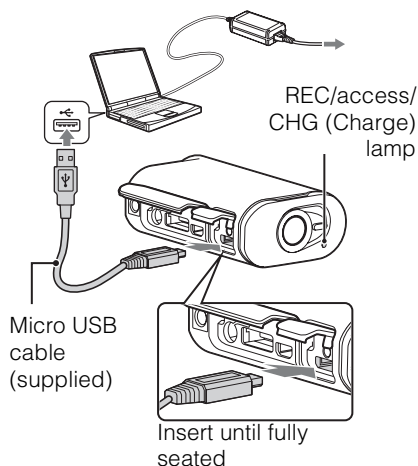

## 3 When charging is finished, delete the USB connection between the camera and the computer.

Charging is complete when the REC/access/CHG (Charge) lamp turns off (full charge) (page 74).

### Notes

- You can use only type X battery with this camera.
- Turn off the camera while charging the battery.
- Do not apply force to the camera, when you connect the camera to a computer. This may cause damage to the camera or the computer.
- When you connect the camera to a notebook computer that is not connected to an AC power source, the battery of the notebook computer may be depleted rapidly. Do not leave the camera connected to the computer for a long time.
- Charging the battery pack or the connection with customized or hand-built computers is not guaranteed. Depending on the type of USB device used, charging may not function properly.
- Operation with all computers is not assured.
- If you do not intend to use the camera for an extended period, charge the camera once every 6 to 12 months to maintain battery performance.

## 💡 How long does it take to charge the camera?

### Charging time

Battery pack	Via a computer	Via AC-UD20* (sold separately)
NP-BX1 (supplied)	Approx. 245 min.	Approx. 175 min.

- Time required to charge a fully depleted battery pack at a temperature of 25°C (77°F). Charging may take longer under certain circumstances or conditions.

\* Rapid charging is possible by using the USB charger AC-UD20 (sold separately). To connect to the charger, use the micro USB cable (supplied).



## Checking the remaining battery charge

A remaining charge indicator appears on the upper right of the display panel.

High      Low



- The displayed remaining charge indicator may not be correct under certain circumstances.
- It takes about one minute until the correct remaining charge indicator appears.

Table of contents

Operation Search

Settings Search

Index

# Inserting a memory card

1 Slide the lock lever until the yellow mark can be seen, then open the cover.

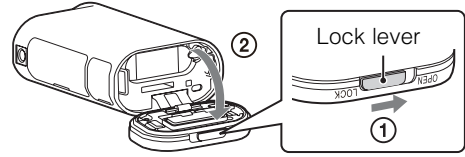

2 Insert the memory card until it clicks.

microSD card: Insert in the direction of **A**.

Memory Stick Micro (M2) media: Insert in the direction of **B**.

- When [WAIT] appears on the display panel, wait until the message disappears.
- Insert a memory card squarely in the correct orientation; otherwise, the camera will not recognize it.

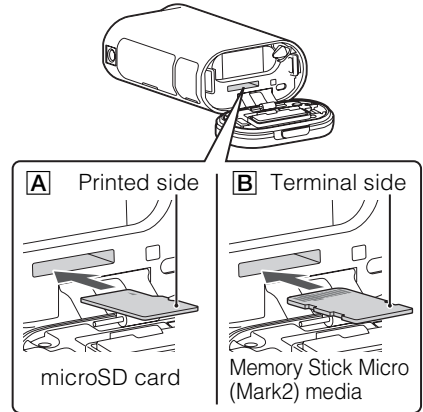

3 Close the cover.

Close the cover properly, so as the yellow mark on the lock lever is not visible.

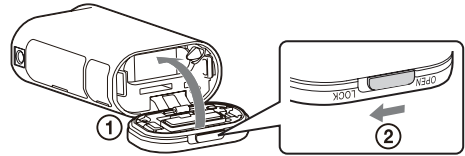

## To eject the memory card

Open the cover, then lightly push the memory card once.





## What types of memory cards you can use with this camera?

### When recording MP4

Types of memory cards	SD Speed Class	Phrase in this book
Memory Stick Micro (Mark2) media	—	Memory Stick Micro media
microSD memory card	Class 4 or faster	microSD card
microSDHC memory card		
microSDXC memory card		

### When recording XAVC S

Types of memory cards	SD Speed Class	Phrase in this book
microSDXC memory card	Class 10 or faster	microSD card

- Operation with all memory cards is not assured.
- An exFAT compatible memory card is required when recording XAVC S.

### Notes

- In order to stabilize memory card operation, it is recommended that you format the memory card when you use it with the camera for the first time (page 44).  
All data recorded on the memory card will be erased by formatting, and cannot be recovered.
- Save important data on the memory card on other media such as a computer, before formatting the memory card.
- If you insert a memory card into the slot in the wrong direction, the memory card, the memory card slot, or image data may be damaged.
- Do not insert anything other than the compliant size of memory card into the memory card slot. Otherwise, a malfunction may result.
- When inserting or ejecting the memory card, be careful to prevent the memory card from popping out and dropping.
- Guaranteed operating temperature of the camera is between  $-10^{\circ}\text{C}$  to  $40^{\circ}\text{C}$  ( $14^{\circ}\text{F}$  to  $104^{\circ}\text{F}$ ). However, depending on the types of memory cards, guaranteed operating temperature varies. For details, refer to the operating instructions supplied with the memory card.
- Images recorded in a microSDXC memory card cannot be transferred or played back on a computer or AV device that is not exFAT\*-compatible (via USB connection). Before connecting, make sure that the device is exFAT-compatible. If the camera is connected to a device that is not exFAT-compatible, a prompt to format the memory card may appear. In this case, do not format the memory card, otherwise all its data will be lost.  
\* exFAT is the file system used by microSDXC memory cards.

# Date & Time Setting

Setting display



You can set the year/month/day and region.

To make the setting, select [SETUP] → [CONFIG] first.

- 1 Press the NEXT button to display [SETUP], then press the ENTER button.
- 2 Press the NEXT button to display [CONFIG], then press the ENTER button.
- 3 Press the NEXT button to display [DATE] (Date Time), then press the ENTER button.
- 4 Press the NEXT button to select the desired date, time and region, then press the ENTER button to confirm.

Select 00:00 for midnight, 12:00 for noon.

Display	Default setting	
	2014	Sets the year.
	01	Sets the month.
	01	Sets the day.
	00	Sets the hour.
	00	Sets the minutes.
	GMT+0	Sets the region in which you use the camera. (Regions are defined by time difference from Greenwich Mean Time (GMT)).

## Notes

- When you set the GPS log to [ON], the camera adjusts date, time and region automatically during shooting mode.

Table of contents

Operation Search

Settings Search

Index

## Setting the region

You can set the clock to the local time of a country you visit by selecting the region. Regions are defined by time difference from Greenwich Mean Time (GMT). Refer also to “World time difference” (page 75).

Table of contents

Operation Search

Settings Search

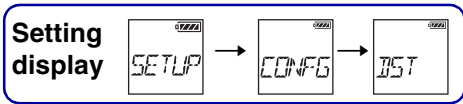

Index

# Daylight Saving Time (Summer Time) Setting



You can set the camera's clock to the Daylight Saving Time.  
To make the setting, select [SETUP] → [CONFIG] first.

- 1 Press the NEXT button to display [SETUP], then press the ENTER button.
- 2 Press the NEXT button to display [CONFIG], then press the ENTER button.
- 3 Press the NEXT button to display [DST] (Daylight Saving Time), then press the ENTER button.
- 4 Press the NEXT button to select the setting, then press the ENTER button.

		Sets the Daylight Saving Time.
✓		Does not set the Daylight Saving Time.
		Returns to the [DST] menu.

# Image Quality Setting Mode



You can set the image resolution and frame rate for shooting movies.  
Image qualities that can be set depend on the [PRO] setting (page 28).

- 1 Press the NEXT button to display [VMODE], then press the ENTER button.
- 2 Press the NEXT button to select the image quality, then press the ENTER button.

## When [PRO] is set to [OFF] (recording in MP4)

	Display	Recorded image	Resolution	Imaging frame rate <sup>*1</sup>	Playback frame rate <sup>*1</sup>
		Highest resolution (smooth image recorded at 2× frame rate)	1920×1080	60p/50p	60p/50p
✓		Highest resolution	1920×1080	30p/25p	30p/25p
		High resolution	1280×720	30p/25p	30p/25p
		High speed recording (smooth image recorded at 4× frame rate) <sup>*2</sup>	1280×720	120p/100p	120p/100p <sup>*3</sup>
		High speed recording (smooth image recorded at 8× frame rate) <sup>*2</sup>	800×480	240p/200p	240p/200p <sup>*3</sup>
		Super slow recording (Super slow motion image recorded at 4× frame rate)	1280×720	120p/100p	30p/25p
		Standard resolution	640×480	30p/25p	30p/25p
		Returns to the [VMODE] menu.			



<sup>\*1</sup> Frame rate depends on the NTSC/PAL setting (page 42).

<sup>\*2</sup> PlayMemories Home™ converts the frame rate to 60p/50p and plays back images at standard speed. It also allows you to play back images in slow motion and edit them during slow motion playback (page 63).



<sup>\*3</sup> Depending on your device and software, images are played back at 60p/50p.

## When [PRO] is set to [ON] (recording in XAVC S)

### When [V.SYS] is set to [NTSC]

	Display	Recorded image	Resolution	Imaging frame rate	Playback frame rate
		XAVC S 50 Mbps	1920×1080	60p	60p
		XAVC S 50 Mbps	1920×1080	30p	30p
		XAVC S 50 Mbps	1920×1080	24p	24p

### When [V.SYS] is set to [PAL]

	Display	Recorded image	Resolution	Imaging frame rate	Playback frame rate
		XAVC S 50 Mbps	1920×1080	50p	50p
		XAVC S 50 Mbps	1920×1080	25p	25p

### Notes

- Continuous movie shooting time is approximately 13 hours.  
In [SSLOW] mode, it is approximately 3 hours.
- Audio is not recorded when shooting in [SSLOW] mode.
- The field angle changes when the Image Quality Setting Mode is set to [HS120]/[HS100], [HS240]/[HS200], [SSLOW], or [VGA].
- SteadyShot is not effective when the Image Quality Setting Mode is set to [HS120]/[HS100], [HS240]/[HS200] or [SSLOW].
- When you play images recorded in [HS120]/[HS100] or [HS240]/[HS200], the frame rate will be 60p/50p, and playback will be standard speed.

# SteadyShot

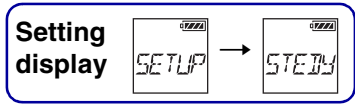

You can activate the camera-shake reduction when shooting.  
To make the setting, select [SETUP] first.

- 1 Press the NEXT button to display [SETUP], then press the ENTER button.
- 2 Press the NEXT button to display [STEDY] (SteadyShot), then press the ENTER button.
- 3 Press the NEXT button to select the setting, then press the ENTER button.

✓		Uses SteadyShot. (Field angle: 120°)
		Does not use SteadyShot. (Field angle: 170°)
		Returns to the [STEDY] menu.

## Notes

- The field angle is 120° at the default setting. For a wider field angle, set [STEDY] to [OFF].
- The field angle changes when the Image Quality Setting Mode is set to [HS120]/[HS100], [HS240]/[HS200], [SSLOW], or [VGA].
- SteadyShot is not effective in the following settings.
  - When the Image Quality Setting Mode is set to [HS120]/[HS100], [HS240]/[HS200] or [SSLOW]
  - In the photo mode
  - In the interval photo recording mode

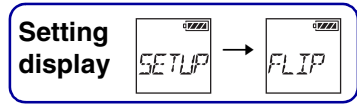

# Flip



You can record the image upside down. This function is useful when the camera is attached upside down.

To make the setting, select [SETUP] first.

- 1 Press the NEXT button to display [SETUP], then press the ENTER button.
- 2 Press the NEXT button to display [FLIP] (Flip), then press the ENTER button.
- 3 Press the NEXT button to select the setting, then press the ENTER button.

		Flips the image vertically and swaps the left and right sound channels.
✓		Does not flip the image.
		Returns to the [FLIP] menu.



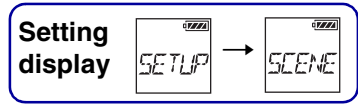

# Scene



You can select suitable image quality according to the shooting scene.  
To make the setting, select [SETUP] first.

- 1 Press the NEXT button to display [SETUP], then press the ENTER button.
- 2 Press the NEXT button to display [SCENE] (Scene), then press the ENTER button.
- 3 Press the NEXT button to select the setting, then press the ENTER button.

✓		Shoots images in the standard quality.
		Shoots images in an image quality suitable for underwater shooting.
		Returns to the [SCENE] menu.

## Notes

- Attach the Waterproof Case to the camera when using in water (page 46).

# Interval Photo Recording

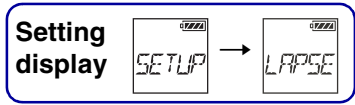

You can set the interval period of the interval photo recording.  
To make the setting, select [SETUP] first.

- 1 Press the NEXT button to display [SETUP], then press the ENTER button.
- 2 Press the NEXT button to display [LAPSE] (Interval), then press the ENTER button.
- 3 Press the NEXT button to select the setting, then press the ENTER button.

		Continues to record photos at about 1-second intervals.
✓		Continues to record photos at about 2-second intervals.
		Continues to record photos at about 5-second intervals.
		Continues to record photos at about 10-second intervals.
		Continues to record photos at about 30-second intervals.
		Continues to record photos at about 60-second intervals.
		Returns to the [LAPSE] menu.

## Notes

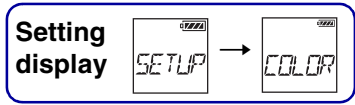

- The first photo is recorded immediately after recording is started, without waiting for the completion of the set interval. From the second photo, photos will be recorded at the set intervals.
- The maximum number of recordable files is 40,000 in total, including movie files.

# Color Setting



You can change the image color tone when shooting.  
To make the setting, select [SETUP] first.

- 1 Press the NEXT button to display [SETUP], then press the ENTER button.
- 2 Press the NEXT button to display [COLOR] (Color), then press the ENTER button.
- 3 Press the NEXT button to select the setting, then press the ENTER button.

		Records in natural colors.
✓		Records in vivid colors.
		Returns to the [COLOR] menu.

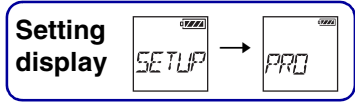

# XAVC S



This setting is suitable for professional movie shooting. The format when recording movies will be XAVC S, and you can record high quality images at a high bit rate of approximately 50 Mbps. You can change the time code/user bit setting when [PRO] is set to [ON].

To make the setting, select [SETUP] first.

- 1 Press the NEXT button to display [SETUP], then press the ENTER button.
- 2 Press the NEXT button to display [PRO] (Pro), then press the ENTER button.
- 3 Press the NEXT button to select the setting.

		Records in XAVC S. Select image quality on Image Quality Setting Mode (page 21).
✓		Records in MP4. Select this when copying images to your smartphone or uploading images to a website.
		Returns to the [PRO] menu.

## Notes

- A compatible memory card is required when recording XAVC S (page 17).

# Time Code/User Bit

Setting display

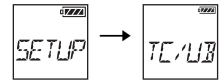

You can use the time code/user bit when [PRO] is set to [ON].

You can set the following settings from [TC/UB].

To make the setting, select [SETUP] first.

- 1 Press the NEXT button to display [SETUP], then press the ENTER button.
- 2 Press the NEXT button to display [TC/UB], then press the ENTER button.
- 3 Press the NEXT button to select [TCSET] or [UBSET], then press the ENTER button.
- 4 Press the NEXT button to select the setting, then press the ENTER button.







		<p>Sets the time code.</p> <ul style="list-style-type: none"> <li>• Set four 2-digit numbers, then press the ENTER button.</li> <li>• The time code can be selected within the following range. <ul style="list-style-type: none"> <li>– When selecting 30p or 60p 00:00:00:00 (default) - 23:59:59:29</li> <li>– When selecting 25p or 50p 00:00:00:00 (default) - 23:59:59:24</li> </ul> </li> <li>• When selecting 24p, you can set the last 2 time code digits of the frames in multiples of 4, between 0 and 23.</li> </ul>
		<p>Initializes the time code.</p> <ul style="list-style-type: none"> <li>• Press the ENTER button to display [SURE?] while [OK] is displayed, then press the ENTER button again.</li> </ul>
		<p>Selects the time code recording method.</p> <p><b>DF</b> Records the time code in drop frame (default).</p> <p><b>NDF</b> Records the time code in non-drop frame.</p> <ul style="list-style-type: none"> <li>• In the following situations, time code is recorded in [NDF], and [FORMAT] will not be displayed. <ul style="list-style-type: none"> <li>– When [VMODE] is set to 24p</li> <li>– When [V.SYS] is set to [PAL]</li> </ul> </li> </ul>
		<p>Sets how the time code advances.</p> <p><b>REC</b> The time code advances only while recording XAVC S movies. It is recorded sequentially from the time code on the image recorded last time (default).</p> <p><b>FREE</b> The time code advances sequentially, regardless of the operation of the camera.</p>
		<p>Sets the recording time code.</p> <p><b>PRESET</b> The newly set-up time code is recorded on recording media (default).</p> <p><b>REGEN</b> The last time code of the previous recording is read out from the recording media and the new time code is recorded sequentially from the last time code.</p> <ul style="list-style-type: none"> <li>• The time code advances in [REC] mode regardless of the setting of [RUN].</li> </ul>
		<p>Returns to the [TCSET] menu.</p>

Table of contents

Operation Search

Settings Search

Index

		<p>Sets the user bit.</p> <ul style="list-style-type: none"> <li>Set four 2-digit numbers, then press the ENTER button.</li> <li>The user bit can be selected within the following range. 00:00:00:00 (default) - FF:FF:FF:FF</li> </ul>
		<p>Initializes the use bit.</p> <ul style="list-style-type: none"> <li>Press the ENTER button to display [SURE?] while [OK] is displayed, then press the ENTER button again.</li> </ul>
		<p>Sets the recording time of the user bit.</p> <p><b>OFF</b> Does not record the time as a user bit (default). <b>ON</b> Records the time as a user bit.</p>
		Returns to the [UBSET] menu.

### Notes

- When [PRO] is set to [OFF], [TC/UB] is not displayed (page 28).



### About time code

Time code is a useful function for advanced image editing, by recording hours/minutes/seconds/frames on the image data.

When [V.SYS] is set to [NTSC] and the frame rate is 30p or 60p, gaps in the actual time occur during extended periods of recording as there is a slight difference between the number of frames of the time code and the actual frame frequency of NTSC image signal per second. Drop frame corrects this gap to make time code and actual time equal. The first 2 frame numbers (for 30p, or the first 4 frame numbers for 60p) are removed every minute except in every tenth minute. Time code without this correction is called non-drop frame.



### About the user bit

User bit is a function that can record information (8-digit hexadecimal numbers) such as date/time/scene number. This function is useful for editing movies created using two or more cameras.

# IR-Remote Controller

Setting  
display

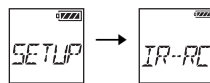

You can start/stop recording and initialize the time code using the infrared remote controller (RMT-845 (sold separately)).

To make the setting, select [SETUP] first.

- 1 Press the NEXT button to display [SETUP], then press the ENTER button.
- 2 Press the NEXT button to display [IR-RC] (IR-Remote Controller), then press the ENTER button.
- 3 Press the NEXT button to select the setting, then press the ENTER button.

		Allows you to operate the camera using the infrared remote controller.
✓		Prevents operation of the camera using the infrared remote controller.
		Returns to the [IR-RC] menu.

## Notes

- The infrared remote controller RMT-845 (sold separately) is required to use this function. Purchase it at a Sony service center.
- You can operate only the following settings using the RMT-845 (sold separately). Other settings are inoperable.
  - Initialize the time code.
  - Start/stop recording.

Table of  
contents

Operation  
Search

Settings  
Search

Index

# Configuration Settings

Setting display

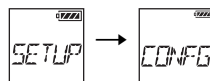

You can set the following settings from [CONFIG].  
Click each item to jump to the corresponding page.  
See page 9 for the hierarchical menu structure of the camera.

Items	Display
Wi-Fi Remote Control	Wi-Fi
GPS Log	GPS
Airplane Mode	PLANE
USB Power Supply	USBPw
Auto Power Off	A.OFF
Beep	BEEP
Date & Time Setting	DATE
Daylight Saving Time (Summer Time) Setting	DST
Language Setting	LANG
Switching NTSC/PAL	V.SYS
Resetting the Settings	RESET
Format	FORMT

Table of contents

Operation Search

Settings Search

Index



# Wi-Fi Remote Control

Setting display



By connecting the camera and a Live-View Remote or smartphone through Wi-Fi, you can operate the camera by the Live-View Remote or smartphone.

To make the setting, select [SETUP] → [CONFG] first.

- 1 Press the NEXT button to display [SETUP], then press the ENTER button.
- 2 Press the NEXT button to display [CONFG], then press the ENTER button.
- 3 Press the NEXT button to display [Wi-Fi] (Wi-Fi), then press the ENTER button.
- 4 Press the NEXT button to select the setting, then press the ENTER button.

✓		Operates a camera by a Live-View Remote or smartphone.
		Does not operate by a Live-View Remote or smartphone.
		Operates multiple cameras by a Live-View Remote. <b>NEW</b> Select this when connecting the camera to a Live-View Remote for the first time. <b>CRRNT</b> Select this when you have connected the camera to a Live-View Remote before.
		Returns to the [Wi-Fi] menu.

- 5 Display [MOVIE], [PHOTO] or [INTVL].
- 6 Connect the camera to the Live-View Remote or smartphone through Wi-Fi.  
For details of the connecting method, see page 61 for a Live-View Remote and see page 56 for a smartphone.
- 7 Operate the camera by the Live-View Remote or smartphone.

## Notes

- The camera battery charge may be consumed quickly if the camera is operated by the Live-View Remote or smartphone.
- [CRRNT] in [MULTI] is not displayed on the display panel of the camera when you connect the camera to the Live-View Remote for the first time.

Table of contents

Operation Search

Settings Search

Index

# Copy

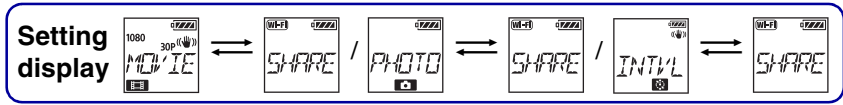

You can copy movies and photos shot by the camera by operating a smartphone.

- 1 Turn on the power of the camera, then press the NEXT button and select a shooting mode.

MOVIE: Movie mode

PHOTO: Photo mode

INTVL: Interval photo recording mode

- 2 Start PlayMemories Mobile on the smartphone and establish the Wi-Fi connection.

For details on the smartphone setting, see “Connecting to your smartphone” on page 57.

- 3 Change the mode of the camera to the copy mode on the PlayMemories Mobile screen of the smartphone.
- 4 Select the image(s) to be copied.

## Notes

- Before activating the Wi-Fi remote control function, update the PlayMemories Mobile software to the latest.
- You can copy images to your smartphone when the camera is set to a shooting mode (movie mode/photo mode/interval photo recording mode).
- You can change the mode only when shooting is in standby.
- You cannot copy XAVC S movies recorded when [PRO] was set to [ON].

# GPS Log

Setting display



You can record the location information and the movement speed while recording movies using the camera's GPS function.

PlayMemories Home allows you to import movies recorded with GPS log to a computer and view them with a map showing location information (page 63).

- 1 Press the NEXT button to display [SETUP], then press the ENTER button.
- 2 Press the NEXT button to display [CONFIG], then press the ENTER button.
- 3 Press the NEXT button to display [GPS] (GPS), then press the ENTER button.
- 4 Press the NEXT button to select the setting, then press the ENTER button.

✓		Records movies with the GPS log and still images with location information.
		Does not use GPS log.
		Returns to the [GPS] menu.

## Notes

- GPS log is recorded only when recording movies.
- If you do not record the location information, set the GPS log to [OFF].
- During takeoff and landing of an airplane, set the airplane mode to [ON] (page 37).
- Use GPS in accordance with the regulations of the place or situation.
- It may take from several tens of seconds to several minutes to record the location information when you use the GPS for the first time or use it again after long intervals. Triangulating time can be shortened by taking in GPS assist data (page 36).
- Do not cover the GPS sensor with your finger when searching for GPS satellites or when triangulating. This decreases the sensitivity of the GPS sensor and triangulation may fail (page 11).
- Sony does not collect location information and routing information.
- To display location information and routing information as a map on a computer, Sony provides data of location information and routing information to Google Inc.
- Although the camera does not have the function to delete log files, you can delete them by formatting the media.
- When shooting still images while GPS log is set to [ON], only the location information will be recorded.
- The maximum number of log files that can be recorded is 256/day. When the maximum number of recorded log files is reached, you can continue to shoot images, however log files will not be recorded.

Table of contents



Operation Search

Settings Search

Index

## Checking triangulating status

The indicator changes according to the strength of GPS signal reception when GPS is activated.

GPS Indicators	Triangulating status	GPS reception status
No indicator	OFF	The GPS log is set to [OFF] or an error occurred.
	Searching/Difficult	Searching for GPS satellites. (It may take several minutes to start triangulating.)
	Triangulating	Your camera is receiving a GPS signal. (Your camera can record location information.)

### About GPS assist data

The time for the GPS acquiring location information can be shortened by taking in GPS assist data. If connection via Internet is made using the software, PlayMemories Home, the GPS assist data can be updated automatically.

- If the Date & Time Setting is not set, or set time is shifted greatly, the time for the GPS acquiring location information cannot be shortened.
- If the term of validity of GPS assist data has run out, the time until you can record location information cannot be shortened.

#### Using the GPS support tool

You can also update the GPS assist data by inserting a memory card into the computer. Display the main screen of PlayMemories Home and select the connected model name → [GPS Support Tool] → the desired memory card drive to be installed from your computer, and then update the GPS assist data. If you insert this memory card, the GPS assist data will be reflected on the camera.

# Airplane Mode

Setting display



When you are in an airplane or another restricted place, you can set the camera to disable all functions related to the wireless applications such as Wi-Fi/GPS, etc. If you set the airplane mode to [ON], an airplane mark will be displayed on the display panel.

- 1 Press the NEXT button to display [SETUP], then press the ENTER button.
- 2 Press the NEXT button to display [CONFIG], then press the ENTER button.
- 3 Press the NEXT button to display [PLANE] (Airplane Mode), then press the ENTER button.
- 4 Press the NEXT button to select the setting, then press the ENTER button.

		Select this when you are on board an airplane. (The Wi-Fi/GPS function is disabled.)
✓		Select this for normal use. (The Wi-Fi/GPS function is enabled.)
		Returns to the [PLANE] menu.

Table of contents

Operation Search

Settings Search

Index

# USB Power Supply



Setting display



When connecting the camera to a computer or USB device with the micro USB cable (supplied), the camera can be set so the connected device supplies power to it.

To make the setting, select [SETUP] → [CONFIG] first.

- 1 Press the NEXT button to display [SETUP], then press the ENTER button.
- 2 Press the NEXT button to display [CONFIG], then press the ENTER button.
- 3 Press the NEXT button to display [USBPw] (USB Power), then press the ENTER button.
- 4 Press the NEXT button to select the setting, then press the ENTER button.

✓		Supplies power from a connected device, through the micro USB cable.
		Does not supply power from a connected device, through the micro USB cable.
		Returns to the [USBPw] menu.

## Notes

- If you change the setting of the USB power supply while the micro USB cable is connected, disconnect the cable, then reconnect.
- Power may not be supplied properly from a USB device with a power supply capacity of less than 1.5 A.
- If you turn the power of the camera on while charging the battery pack, charging stops and power is supplied to the camera from a device connected via USB.



## How to supply power from a wall outlet (wall socket)

Use the USB charger AC-UD20 (sold separately). To connect the camera to the charger, use the micro USB cable (supplied).

Table of contents

Operation Search

Settings Search

Index

# Auto Power Off

Setting display



You can change the setting of the Auto Power Off function.  
To make the setting, select [SETUP] → [CONFIG] first.

- 1 Press the NEXT button to display [SETUP], then press the ENTER button.
- 2 Press the NEXT button to display [CONFIG], then press the ENTER button.
- 3 Press the NEXT button to display [A.OFF] (Auto Power Off), then press the ENTER button.
- 4 Press the NEXT button to select the setting, then press the ENTER button.

		Turns the power off after about 10 seconds.
✓		Turns the power off after about 60 seconds.
		Does not turn off automatically.
		Returns to the [A.OFF] menu.

## Notes

- This function is not available in the following situations.
  - Recording data to media
  - Shooting movies, or shooting in interval photo recording mode
  - During movie playback, or a slideshow
  - Wi-Fi connection is in process, Wi-Fi remote control is being connected, or an image is being uploaded to a smartphone
  - HDMI connection is being made
  - Supplying power from a connected USB device
  - Connecting a mass storage device
- In the following cases, even if you have selected [10sec] or [60sec] in the Auto Power Off function, the time that elapses before the power turns off will be extended.
  - While adjusting [SETUP] settings
  - While playing back photos
  - When [Wi-Fi] is set to [ON] and the Wi-Fi icon is displayed.

Table of contents

Operation Search

Settings Search

Index

# Beep





## Setting display



You can set the audible notification of operations to ON/OFF.

To make the setting, select [SETUP] → [CONFIG] first.

- 1 Press the NEXT button to display [SETUP], then press the ENTER button.
- 2 Press the NEXT button to display [CONFIG], then press the ENTER button.
- 3 Press the NEXT button to display [BEEP] (Beep), then press the ENTER button.
- 4 Press the NEXT button to select the setting, then press the ENTER button.

✓		All operation sounds are enabled.
		Operation sounds are emitted for the following operations only. <ul style="list-style-type: none"><li>• Power turned on</li><li>• Recording started</li><li>• Recording stopped</li><li>• Shutter pressed</li><li>• A disabled operation was selected or an error occurred</li></ul>
		All operation sounds are disabled.
		Returns to the [BEEP] menu.



# Language Setting

Setting display



You can set the displayed language.

To make the setting, select [SETUP] → [CONFIG] first.

- 1 Press the NEXT button to display [SETUP], then press the ENTER button.
- 2 Press the NEXT button to display [CONFIG], then press the ENTER button.
- 3 Press the NEXT button to display [LANG] (Language), then press the ENTER button.
- 4 Press the NEXT button to select the setting, then press the ENTER button.





✓		Sets English.
		Sets French.
		Sets Brazilian Portuguese.
		Returns to the [LANG] menu.

Table of contents

Operation Search

Settings Search

Index

# Switching NTSC/PAL

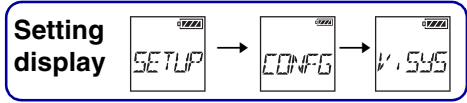

You can select NTSC/PAL, depending on the TV system of the country or region where you use this camera.

To make the setting, select [SETUP] → [CONFG] first.

- 1 Press the NEXT button to display [SETUP], then press the ENTER button.
- 2 Press the NEXT button to display [CONFG], then press the ENTER button.
- 3 Press the NEXT button to display [V.SYS] (Video System), then press the ENTER button.
- 4 Press the NEXT button to select the setting, then press the ENTER button.

✓		When the TV system is NTSC.
		When the TV system is PAL.
		Returns to the [V.SYS] menu.

- 5 Press the NEXT button, then press the ENTER button while [OK] is displayed on the display panel.

To cancel the NTSC/PAL setting, press the NEXT button while [OK] is displayed, select [CANCL], then press the ENTER button.

## Notes

- When you change the NTSC/PAL setting, the camera will restart automatically.
- Recording media formatted or recorded in NTSC cannot be recorded or played in PAL, and vice versa. If [FORMT] appears on the display panel after switching the NTSC/PAL setting, go to the confirmation screen and select [OK], then format the current recording media, or use another recording media (page 44).

# Resetting the Settings

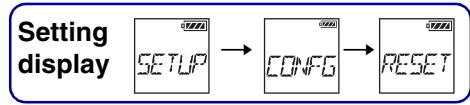

You can reset the settings to their defaults.  
If you activate [RESET], images are not deleted.

- 1 Press the NEXT button to display [SETUP], then press the ENTER button.
- 2 Press the NEXT button to display [CONFIG], then press the ENTER button.
- 3 Press the NEXT button to display [RESET] (Reset), then press the ENTER button.
- 4 Press the ENTER button to display [SURE?] while [OK] is displayed, then press the ENTER button again.

The camera automatically restarts when resetting is complete.

To cancel resetting, press the NEXT button while [SURE?] or [OK] is displayed, select [CANCL], then press the ENTER button.

# Format

## Setting display



Formatting is the process of deleting all images in the memory card, and restoring the memory card to its initial state.

To make the setting, select [SETUP] → [CONFIG] first.

- 1 Press the NEXT button to display [SETUP], then press the ENTER button.
- 2 Press the NEXT button to display [CONFIG], then press the ENTER button.
- 3 Press the NEXT button to display [FORMT] (Format), then press the ENTER button.
- 4 Press the ENTER button to display [SURE?] while [OK] is displayed, then press the ENTER button again.

Formatting starts and [DONE] appears when formatting finishes.

To cancel formatting, press the NEXT button while [SURE?] or [OK] is displayed, select [CANCL], then press the ENTER button.

### Notes

- Save important images before formatting.
- Do not perform any of the following operations while formatting.
  - Press a button.
  - Eject the memory card.
  - Connect/disconnect a cable.
  - Insert/remove the battery pack.

# Using accessories

Refer to the website of this camera for the latest information on accessories.

## Tripod Adaptor

By attaching the Tripod Adaptor to the camera, you can attach accessories to the camera without using the Waterproof Case. Opening/closing the connector cover of the Multi/Micro USB Terminal is also possible. This enables you to connect the camera to a computer or a USB device while the Tripod Adaptor is attached.

### Attachment method

- 1 Fix the screw of the Tripod Adaptor in the tripod adaptor attachment hole of the camera.
- 2 Hold the Tripod Adaptor against the bottom of the camera, and tighten the screw in the direction of the arrow.

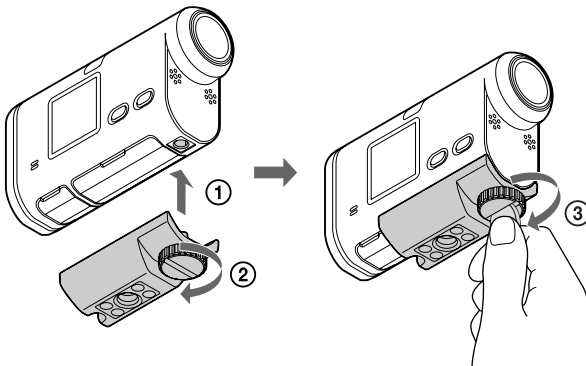

### Removing method

- 1 Loosen the screw of the Tripod Adaptor in the direction of the arrow.
- 2 Remove the Tripod Adaptor from the camera.

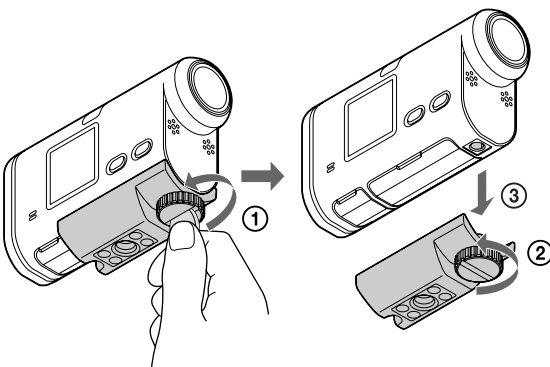

### Notes

- Attach the Waterproof Case to the camera when using in water (page 46).

# Waterproof Case (SPK-AS2)

By inserting the camera in the Waterproof Case, you can shoot movies at a beach.

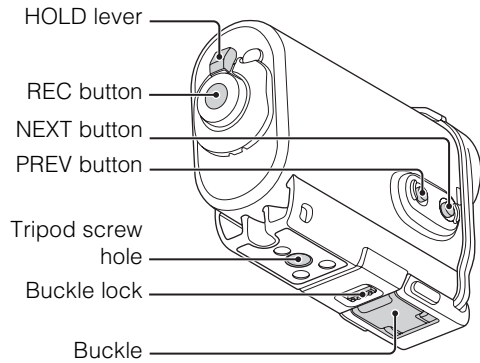
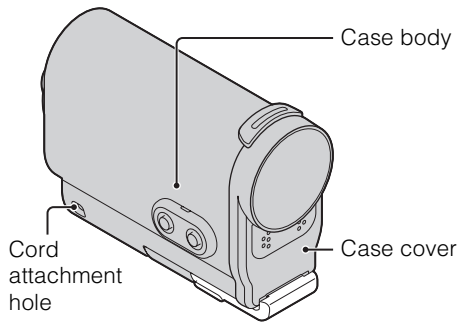

## Attachment method

- 1 Slide the buckle lock in the direction of ① and hold it, then hold the circled parts and swing out the buckle in the direction of ②.

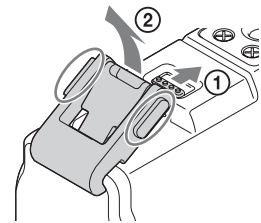

- 2 Open the case cover.

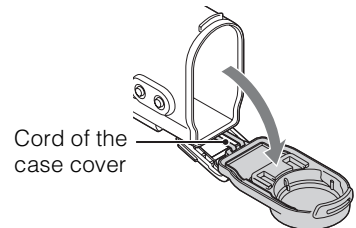

- 3 Insert the camera in the case body.
  - Release the REC HOLD (lock) switch on the camera.

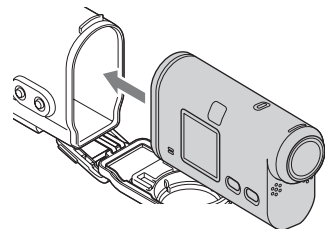

- 4 Insert the tab of the case body into the slot of the case cover.

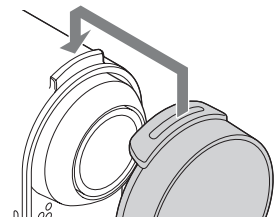

Table of contents

Operation Search

Settings Search

Index

5 Hook the buckle over the tab on the lower part of the case cover ①, then close the buckle in the direction of ②, until it clicks into place.

- Close the buckle until the buckle lock returns to the original position.

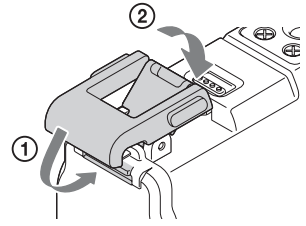

## On waterproof performance of the Waterproof Case

- When inserted in the Waterproof Case, the camera can be used at a water depth of 5 meters for 30 minutes.
- The waterproof performance is based on the testing standards of our company.
- Do not subject the Waterproof Case to pressurized water, such as from a tap.
- Do not use the Waterproof Case in hot springs.
- Use the Waterproof Case only in the recommended operating water temperature of up to 40°C (104°F).
- Sometimes waterproof performance is lost if the Waterproof Case is subjected to a strong shock such as from being dropped. We recommend the Waterproof Case be inspected at an authorized repair shop (chargeable).
- If you use the camera at a water depth of 5 m or more, or in marine sports, use the Waterproof Case (SPK-AS1) (sold separately).

### Notes

- You cannot operate the REC button when the HOLD lever is set to the lock position. Release the lock before operation.
- When recording images underwater with the camera in the Waterproof Case, recorded images appear less clear than those of normal recording. This is not a malfunction.
- You can record audio while the camera is in the Waterproof Case, but the sound level is reduced.
- Thread a suitable cord through the attachment hole of the Waterproof Case, then attach the cord to an item you intend to use with the camera.

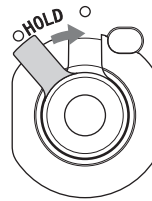

## Notes on use

- Do not throw the Waterproof Case into the water.
- Avoid using the Waterproof Case under the following situations:
  - In a very hot or humid place
  - In water hotter than 40°C (104°F)
  - At temperatures lower than –10°C (14°F)

In these situations moisture condensation or water leakage may occur and damage the camera.

- Do not leave the Waterproof Case under direct sunlight or in a very hot and humid place for a long period of time. If you cannot avoid leaving the Waterproof Case under direct sunlight, be sure to cover the Waterproof Case with a towel or other protection.
- When the camera overheats, it may automatically turn off or recording may malfunction. To use the camera again, leave it in the cool place for a while to cool down.
- If sun oil is on the Waterproof Case, be sure to wash it off thoroughly using lukewarm water. If the Waterproof Case is left with sun oil on its body, the surface of the Waterproof Case may become discolored or damaged (such as cracks on the surface).

## Water leakage

In the unlikely event that a malfunction of the Waterproof Case causes damage due to water leakage, Sony does not guarantee against damages to the equipment contained in it (camera, battery pack, etc.) and the recorded contents, nor expenses entailed in the photography.

## O-ring

The Waterproof Case uses an O-ring to maintain its water resistance.

O-ring maintenance is very important. Failure to do O-ring maintenance according to the instructions may lead to water leaks and cause the Waterproof Case to sink.

### Inspect the O-ring

- Carefully check that there is any dirt, sand, hair, dust, salt, threads, etc. on the O-ring. If found, be sure to wipe off with a soft cloth.
- Lightly run your fingertip around the O-ring to check for any invisible dirt.
- Be careful not to leave any cloth fibers on the O-ring after wiping it.
- Check the O-ring for cracks, skewing, distortion, fine splitting, scratches, embedded sand, etc. Replace the O-ring if you find any of these.
- Inspect the O-ring contact surface on the case body in the same way.

## How to check for water leaks

Before installing the camera, always close the Waterproof Case and immerse it in water to make sure no water leaks in.

### O-ring serviceable life

The serviceable life of the O-ring varies with frequency of use of the Waterproof Case and conditions. Generally, it is about one year.



## Maintenance

- After recording in a location with a sea breeze, wash this unit thoroughly in fresh water with the buckle fastened to remove salt and sand, then wipe with a soft dry cloth. It is recommended that you submerge the Waterproof Case in fresh water for about 30 minutes. If it is left with salt on it, metal portions may be damaged or rust may form and cause water leakage.
- If sun oil is on the Waterproof Case, be sure to wash it off thoroughly using lukewarm water.
- Wipe the inside of the Waterproof Case with a soft dry cloth. Do not wash it with water.

Be sure to perform the above maintenance each time you use the Waterproof Case.

Do not use any type of solvent such as alcohol, benzine or thinner for cleaning, as this might damage the surface finish of the Waterproof Case.

### When storing the Waterproof Case

- To prevent deterioration of the O-ring, store the Waterproof Case in a cool, well-ventilated location. Do not fasten the buckle.
- Prevent dust from collecting on the O-ring.
- Avoid storing the Waterproof Case in a cold, very hot or humid place, or together with naphthalene or camphor, as these conditions might damage the Waterproof Case.

Table of  
contents

Operation  
Search

Settings  
Search

Index

# Adhesive Mount (VCT-AM1)

The Adhesive Mount is used for fixing the Waterproof Case or Tripod Adaptor to an item you intend to use. The Adhesive Mount is a general term for the Attachment Buckle, Flat Adhesive Mount, and Curved Adhesive Mount. Before attaching, insert the camera in the Waterproof Case or attach the Tripod Adaptor.

## Attachment Buckle

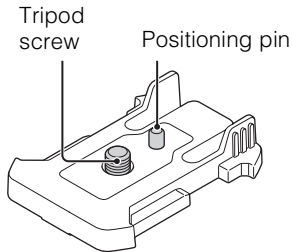

## Flat Adhesive Mount

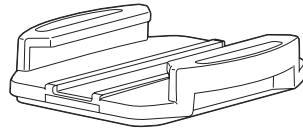

## Curved Adhesive Mount

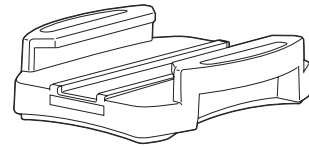

## Attachment method

The procedure below explains the attachment method of the Waterproof Case.

- 1 Align the tripod screw hole in the bottom of the Waterproof Case with the tripod screw hole of the Attachment Buckle, and fix firmly with the tripod screw.

- Confirm that the assembly is fixed securely.

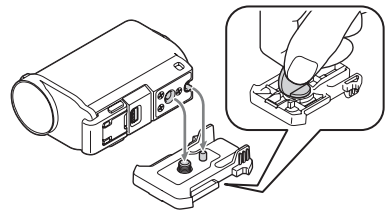

- 2 Attach the Attachment Buckle (with the Waterproof Case set in step 1) to the Flat Adhesive Mount or Curved Adhesive Mount by sliding it until it clicks into place.

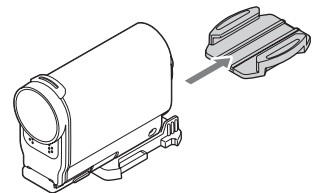

- 3 Remove dust, moisture and oily substances completely from the surface where the Adhesive Mount is to be attached.

- 4 Peel off the release paper on the back, and fix the Adhesive Mount in the desired location.

- Adhesive power reaches its maximum strength 24 hours after the Adhesive Mount is attached to the desired location.



To attach to or detach from the Attachment Buckle

Press and hold the circled part to unlock, then slide it in the opposite direction of step 2.

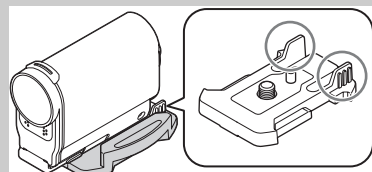

## Notes

- The Flat Adhesive Mount and Curved Adhesive Mount cannot be used again once they are detached from the location surface.
- When detaching, peel off slowly. If peeled off forcibly, the surface on which the mount is fixed might be damaged.
- Before attaching, check the surface of the item to be used. If it is dirty, or dust, moisture or oily substances are attached, adhesive strength may be impaired and the item could detach with slight impact.
- Use the appropriate Adhesive Mount (flat or curved) for the surface where the camera will be located. If the mount is not suitable for the surface, it may detach by slight impact.
- Thread a suitable cord through the attachment hole of the Waterproof Case, then attach the cord to an item you intend to use with the camera.
- Before use, confirm that the screw hole on the Attachment Buckle is not loose, and the flat or curved Adhesive Mount is securely attached to the surface.

Table of  
contents

Operation  
Search

Settings  
Search

Index

# Shooting

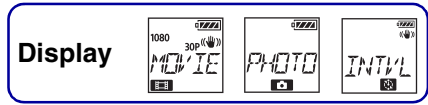

## About the REC HOLD (lock) switch

The REC HOLD (lock) switch can prevent accidental operation. Slide the REC HOLD (lock) switch in the direction of the arrow as illustrated to lock the REC button. To release the lock, slide it in the opposite direction of the arrow.

- Before recording, release the lock.
  - If you lock the camera while recording, the recording state will be kept\*.
  - If you lock the camera after you stop recording, the stopped state will be kept\*.
- \* Release the lock to change the setting.

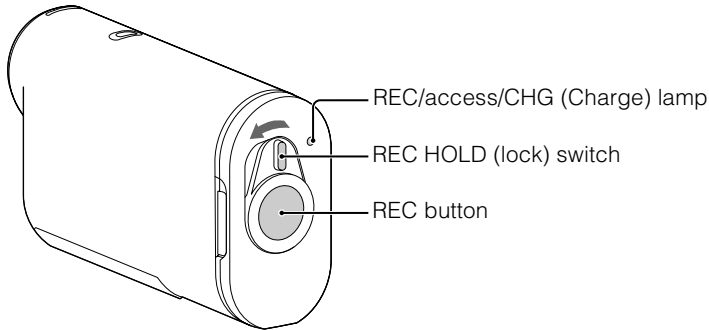

## Movie mode

- 1 Turn on the power, then press the NEXT button to display [MOVIE].
- 2 Press the REC button to start shooting.
- 3 Press the REC button again to stop shooting.

## Photo mode

- 1 Turn on the power, then press the NEXT button to display [PHOTO].
- 2 Press the REC button to shoot.

## Interval photo recording mode

After you start shooting, the camera records still images at regular intervals until you stop shooting.

- 1 Turn on the power, then press the NEXT button to display [INTVL].
- 2 Press the REC button to start shooting.
- 3 Press the REC button again to stop shooting.

### Notes

- The shooting mode set when the camera is turned off will be resumed when the camera is turned on the next time.

## Notes on long-time recording

- When you continue to shoot for a long time, the temperature of the camera rises. If the temperature reaches above a certain level, shooting stops automatically.  
Leave the camera for 10 minutes or longer to allow the temperature inside the camera to decrease to a safe level.
- Under high ambient temperatures, the temperature of the camera rises quickly.
- When the temperature of the camera rises, the image quality may deteriorate. It is recommended that you wait until the temperature of the camera drops before continuing to shoot.
- The surface of the camera may get hot. This is not a malfunction.

Table of  
contents

Operation  
Search

Settings  
Search

Index

# Viewing images on a TV



Connect the camera to a TV which has an HDMI terminal using a micro HDMI cable (sold separately).

Refer also to the instruction manuals of the TV.

- 1 Turn off both the camera and the TV.
- 2 Open the connector cover and connect the camera to the TV with the micro HDMI cable (sold separately).

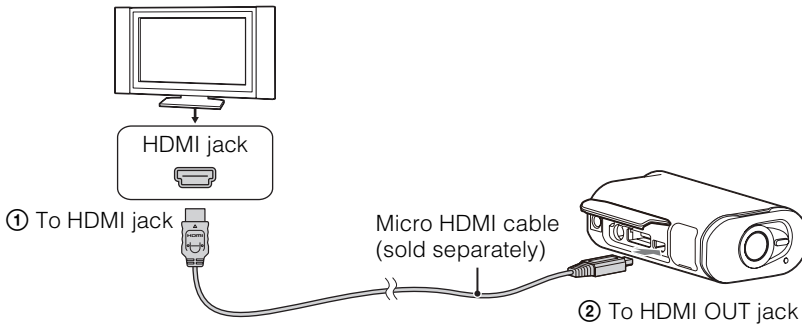

- 3 Set the input of the TV to [HDMI input].
- 4 Press the NEXT button on the camera to turn on.
- 5 Press the NEXT button to display [PLAY], then press the ENTER button.
- 6 Press the NEXT button to display [MP4], [PHOTO] or [PRO], then press the ENTER button.

Select [MP4] to play back movies recorded in MP4, [PHOTO] to view photos, or [PRO] to play images recorded in XAVC S.

Press the ENTER button again to stop playback.

## Notes

- Connect the micro HDMI jack of the micro HDMI cable (sold separately) to the HDMI OUT jack of the camera.
- Do not connect the output terminal of the camera to that of other devices. This may result in malfunction.
- Some devices may not work properly. Image and sound may not be output.
- Use a micro HDMI cable (sold separately) with the HDMI logo.
- It is recommended that you use an authorized cable with HDMI logo or a Sony HDMI cable.

Table of contents

Operation Search

Settings Search

Index

## To control a content being played back

- Viewing the previous/next image: Press the PREV/NEXT button.
- Fast-rewind/fast-forward (movies only): Press and hold the PREV/NEXT button.
- Pause (movies only): Press the PREV and NEXT buttons simultaneously. If you press and hold the PREV or NEXT button during pause, slow rewind or slow forward can be performed.
- Adjusting the volume (movies only): Press and hold the PREV and NEXT buttons simultaneously.
- Starting a slideshow (photos only): Press the PREV and NEXT buttons simultaneously.
- Ending playback: Press the ENTER button.

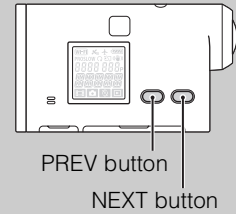

# Preparation for connecting to your smartphone

## Installing the PlayMemories Mobile™ software on your smartphone

Install the PlayMemories Mobile on your smartphone. Update PlayMemories Mobile to the latest version if you have already installed it on your smartphone.

For the latest information and functional detail of PlayMemories Mobile, refer to the following website.

<http://www.sony.net/pmm/>

Search for PlayMemories Mobile on Google Play, then install it.

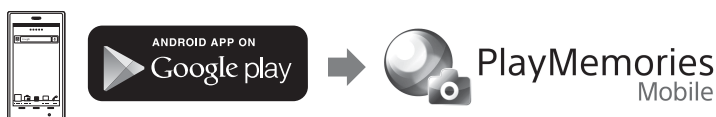

- When using One-touch functions (NFC), Android 4.0 or later is required.

Search for PlayMemories Mobile on App Store, then install it.



- When using iOS, One-touch functions (NFC) are not available.

### Notes

- An NFC-enabled smartphone or tablet is required for using One-touch functions (NFC).
- The Wi-Fi function described here is not guaranteed to work on all smartphones and tablets.

## Preparing the ID/password

- Have ready the sticker attached to the Operating Guide, on which the ID/password is printed.
- The ID/password are not necessary when using one-touch connect by a smartphone.



If the password is lost

- ① Connect the camera to a computer with the micro USB cable (supplied).
- ② Turn on the power.
- ③ Display [Computer] → [PMHOME] → [INFO] → [WIFI\_INF.TXT] on your computer, then check the user ID and password.



# Connecting to your smartphone

Setting display



Perform preparation for connecting to your smartphone before connecting (page 56).

## Android supporting NFC

- 1 Select [SETUP] → [CONFIG] → [Wi-Fi] → [ON] on the camera (page 33).
- 2 Confirm that the camera is in the shooting mode (page 52).

MOVIE: Movie mode

PHOTO: Photo mode

INTVL: Interval photo recording mode

- 3 Select [Settings] on the smartphone, then select [More...] and check that [NFC] is enabled.

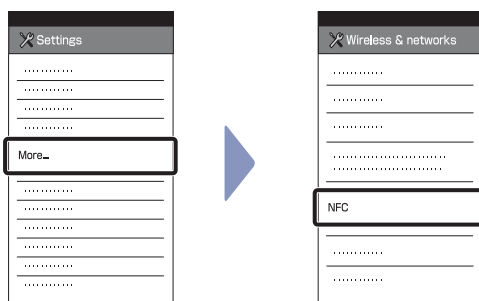

- 4 Touch the smartphone to the camera.

- Cancel sleep and the screen lock of the smartphone beforehand.
- Continue touching without moving until PlayMemories Mobile starts (1-2 seconds).
- Touch the **N** (N Mark) of the smartphone to the **N** (N Mark) of the camera. If there is no **N** (N Mark) on the smartphone, refer to the instruction manual of the smartphone for the touch area.
- If the camera and the smartphone cannot be connected by NFC, see “Android/iPhone not supporting NFC” and connect them.

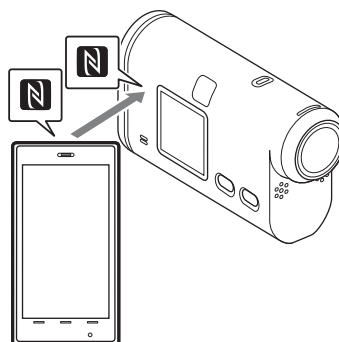

### Notes

- When the airplane mode is set to [ON], the Wi-Fi function is not available.

### About NFC

NFC is a technology for short-range wireless communication between various devices, such as a mobile phone and IC tag etc. Data communication is achieved simply by touching devices together at a specific point.

NFC (Near Field Communication) is an international standard of the short-range wireless communication technology.

Table of contents

Operation Search

Settings Search

Index

# Android/iPhone not supporting NFC

- 1 Select [SETUP] → [CONFIG] → [Wi-Fi] → [ON] on the camera (page 33).
- 2 Confirm that the camera is in the shooting mode (page 52).  
MOVIE: Movie mode  
PHOTO: Photo mode  
INTVL: Interval photo recording mode

## Android

- 1 Start PlayMemories Mobile.
- 2 Select the SSID, as printed on the sticker attached to the Operating Guide.
- 3 Input the password, as printed on the sticker attached to the Operating Guide (First time only).

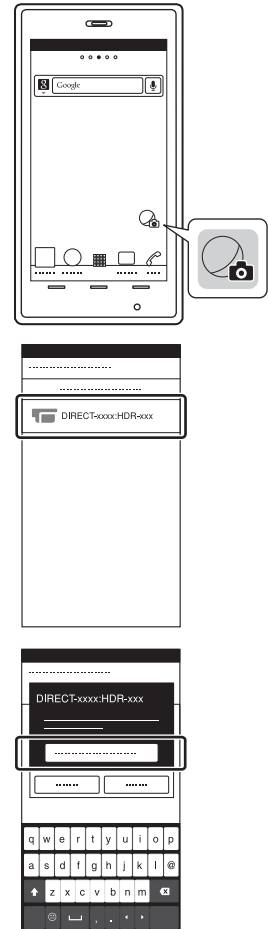

Table of contents

Operation Search

Settings Search

Index

## iPhone/iPad

- 1 Select [Settings] on the smartphone, then select [Wi-Fi] and the SSID of the camera.
- 2 Input the password, as printed on the sticker attached to the Operating Guide (First time only).
- 3 Confirm the connection to the SSID, as printed on the sticker attached to the Operating Guide.
- 4 Return to the home screen and start PlayMemories Mobile.

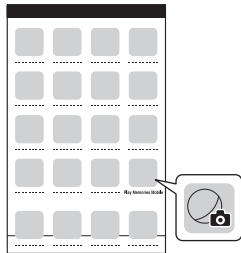
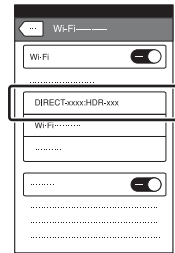
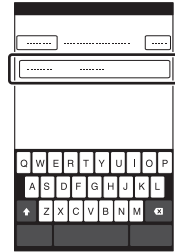
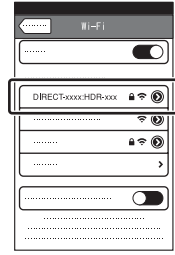

Table of contents

Operation Search

Settings Search

Index

# Sample smartphone screen display

## Features of the Wi-Fi remote control function

- To check the field of view before and while recording
- To monitor images while recording

## Various settings

- [SHARE]
- [VMODE]
- [STEDY]

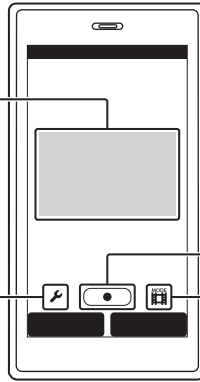

## Start/stop recording

## Shooting mode settings

- [MOVIE]
- [PHOTO]/[INTVL]

## Notes

- You cannot connect a smartphone to two or more cameras at the same time.
- Depending on local electrical interference or the smartphone's capabilities, the live view images may not be displayed smoothly.

Table of contents

Operation Search

Settings Search

Index

# Connecting with the Live-View Remote

With the Live-View Remote (RM-LVR1), you can operate the camera, such as checking the field angle or starting/stopping recording on the Live-View Remote screen, while the camera is placed on your head or at a distant place. You can connect and operate multiple cameras to the Live-View Remote.

## Notes

- Update the Live-View Remote to the latest firmware version before using. For details, visit the website below.  
[www.sony.net/SonyInfo/Support/](http://www.sony.net/SonyInfo/Support/)

## Connecting the Live-View Remote to the camera

- 1 Turn on the power of the Live-View Remote.  
For details on operation, refer to the operating guide of the Live-View Remote.
- 2 Select [SETUP] → [CONFIG] → [Wi-Fi] → [ON] on the camera (page 33).
- 3 Select the SSID of the camera on the Live-View Remote.
- 4 When [ACPT?] is displayed on the display panel of the camera, press the ENTER button of the camera.

## Connecting the Live-View Remote to two or more cameras

You can connect a maximum of five cameras to the Live-View Remote and operate all cameras simultaneously. This is useful when shooting from multiple angles.

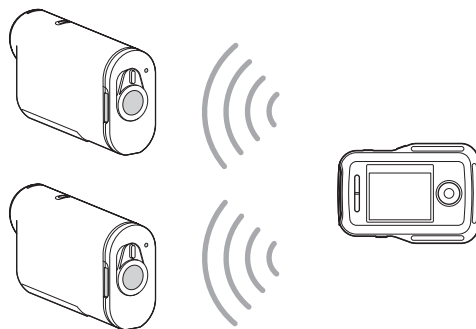

- 1 Turn on the power of the Live-View Remote.  
For details on operation, refer to the operating guide of the Live-View Remote.
- 2 Select [SETUP] → [CONFIG] → [Wi-Fi] → [MULTI] and select the setting on the camera.  
Select [NEW] when connecting the camera to the Live-View Remote for the first time and select [CRRNT] when connecting for the second time and thereafter (page 33).

### 3 When [AWAIT] is displayed on the display panel of the camera, register the camera on the Live-View Remote.

When connecting completes, [DONE] is displayed on the display panel of the camera.  
Connect each camera by performing steps 2 and 3.

#### Notes

- You cannot copy images recorded in the camera to the Live-View Remote.
- The WPS method is used for connecting the Live-View Remote to multiple cameras. If there is another device using the WPS method in the vicinity of the cameras, the registration may fail. If the registration fails, reconnect by performing each step again.

#### To display the [Wi-Fi] menu easily

Press the PREV and NEXT button simultaneously when the camera is in the shooting mode. This is useful when you operate multiple cameras.

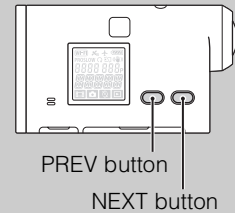

#### How to enjoy images recorded in multiple cameras

You can perform the multi-view editing, which displays movies recorded in multiple cameras on one screen, by using PlayMemories Home.

#### Notes

- The camera should only be connected to a smartphone or a Live-View Remote via Wi-Fi and not other Wi-Fi access points. If you choose to connect the camera to other Wi-Fi access points, then you do so at your own risk as by doing so the camera may be subject to unauthorized access and any content communicated may be at risk of interception.

# Useful functions when connecting the camera to your computer

PlayMemories Home allows you to import movies and still images to your computer to use them in a variety of ways.

Visit the following URL to install the software.

[www.sony.net/pm/](http://www.sony.net/pm/)

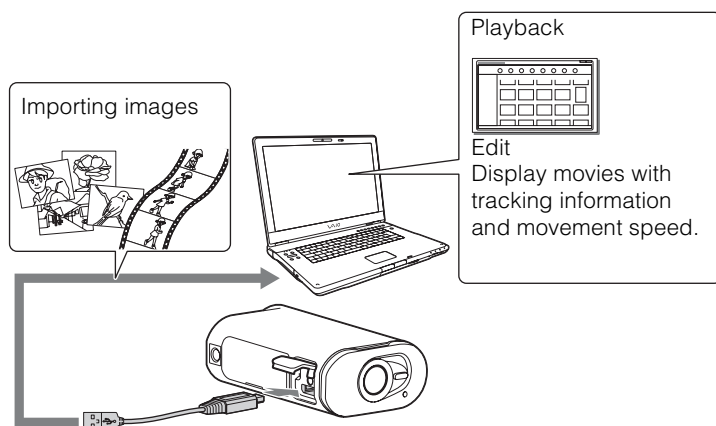

- Use the micro USB cable (supplied) when connecting the camera to your computer.
- Functions of PlayMemories Home that can be used differ for Windows and for Mac.
- For details on other applications, visit the following URL.  
Windows: <http://www.sony.co.jp/imsoft/Win/>  
Mac: <http://www.sony.co.jp/imsoft/Mac/>

## To check the computer environment

For information about the computer environment for the software, refer to the following website.  
[www.sony.net/pcenv/](http://www.sony.net/pcenv/)

## For how to use PlayMemories Home

Refer to the help of PlayMemories Home.

# Preparing a computer

## Installing PlayMemories Home

### 1 Turn on the computer.

- Log on as an Administrator.
- Close all applications running on the computer before installing the software.

### 2 Visit the following URL with the Internet browser of the computer and install PlayMemories Home.

[www.sony.net/pm/](http://www.sony.net/pm/)



- For more information about installing, refer to the PlayMemories Home support page.  
<http://www.sony.co.jp/pmh-se/>
- When the installation completes, PlayMemories Home starts up.

### 3 Connect the camera to the computer with the supplied micro USB cable.

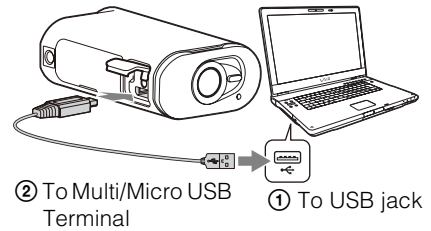
- New function may be added to PlayMemories Home.  
Even if PlayMemories Home is already installed on your computer, connect the camera to your computer.



#### Notes

- Do not disconnect the micro USB cable (supplied) from the camera when the indication meaning operating or accessing the camera is being displayed on the computer screen. Doing so may cause data corruption.
- To disconnect the computer from the camera, click  on the task tray then click  (icon to remove). If you are using Windows Vista, click  on the task tray.



# To delete the USB connection

## Windows 7/Windows 8

- 1 Click  on the task tray.
- 2 Click the disconnect icon in Customize.
- 3 Click the device to remove.

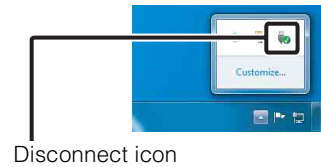

## Windows Vista

Perform the procedure from step 1 to 3 below before:

- Disconnecting the micro USB cable (supplied).
- Turning off the camera.

- 1 Double-click the disconnect icon on the task tray.
- 2 Click  (USB Mass Storage Device) → [Stop].
- 3 Confirm the device on the confirmation window, then click [OK].

### Notes

- Do not format the memory card of the camera using a computer. If you do this, the camera will not operate correctly.
- When you access the camera from the computer, use PlayMemories Home. Do not directly modify the files or folders on the camera from the computer. The image files may be damaged or may not be played back.
- Operation is not guaranteed, if you operate the data on the memory card of the camera from the computer.
- Use PlayMemories Home when you import long movies or edited images from the camera to a computer. If you use other software, the images may not be imported correctly.
- Drag and drop the drive icon to the “Trash” icon when you use a Mac computer, and the camera is disconnected from the computer.

# Troubleshooting

If you experience trouble with the camera, try the following solutions.

**① Check the items on pages 67 to 71.**

**② Turn the power off and then on again.**

**③ Consult your Sony dealer or local authorized Sony service facility.**

Table of  
contents

Operation  
Search

Settings  
Search

Index

## Battery pack and power

### Cannot turn on the camera.

- Attach a charged battery pack.
- Make sure that the battery pack is inserted correctly (page 13).

### The power turns off suddenly.

- Depending on the camera and battery temperature, the power may turn off automatically to protect the camera. In this case, a message is displayed on the display panel before the power turns off.
- If you do not operate the camera for a certain period of time while the power is on, the camera turns off automatically to prevent wearing down the battery pack. Turn the camera on again.
- If you have selected [OFF] in the Auto Power Off function, the power does not turn off automatically.

### Battery life is short.

- You are using the camera in an extremely hot or cold location, or the charging is insufficient. This is not a malfunction.
- If you have not used the camera for a prolonged period, the efficiency of the battery will be improved by repeatedly charging and discharging it.
- When usable battery life becomes half the usual time, even after charging the battery pack fully, the battery pack may need to be replaced. Consult your nearest Sony dealer.

### Cannot charge the camera.

- Turn off the camera and make the USB connection.
- Disconnect the micro USB cable (supplied), and then reconnect it.
- Use the micro USB cable (supplied).
- Charge the battery pack in an ambient temperature of 10°C to 30°C (50°F to 86°F).
- Turn on the computer and connect the camera.
- Release the computer from sleep or hibernation status.
- Connect the camera directly to a computer using the micro USB cable (supplied).
- Connect the camera to a computer with the operating system that is supported by the camera.

### The remaining charge indicator is incorrect.

- This phenomenon occurs when you use the camera in an extremely hot or cold location.
- A discrepancy arose between the remaining charge indicator and the actual remaining battery charge. Fully discharge the battery pack once, then charge it to correct the indication.
- Fully charge the battery pack again. If the problem persists, the battery pack is worn out. Replace the battery pack with a new one.

## Memory card

### Operations using the memory card cannot be performed.

- If you use a memory card formatted on a computer, format it again on the camera (page 44).

## Shooting images

### Cannot record images.

- Check the free capacity of the memory card.

---

### Cannot insert dates on images.

- The camera does not have a feature for superimposing dates on images.

## Viewing images

### Cannot play back images.

- The folder/file name has been changed on your computer.
- Connect a micro HDMI cable (sold separately).

---

### The image does not appear on the TV.

- Check whether the connection is correct (page 54).

## GPS

### The camera is not receiving a GPS signal.

- Set the GPS log to [ON].
- Your camera may not be able to receive radio signals from GPS satellites because of obstructions.
- To triangulate the location information correctly, bring your camera to an open area, and turn on the camera again.

---

### Excessive error in location information.

- The margin of error can be up to several-hundred meters depending on surrounding buildings, weak GPS signals, etc.

---

### It takes time to triangulate although the GPS assist data is taken in.

- Date & Time Setting is not set, or set time is shifted greatly. Set the date and time correctly.
- The term of validity of GPS assist data has expired. Update GPS assist data.
- As the positions of GPS satellites vary constantly, it may take longer to determine the location or the receiver may not be able to determine the location at all, depending on the location and time you use the camera.
- “GPS” is a system for determining geographic location by triangulating radio signals from GPS satellites. Avoid using the camera in places where radio signals are blocked or reflected, such as a shadowy place surrounded by buildings or trees, etc. Use the camera in open sky environments.

---

### The location information has not been recorded.

- Use PlayMemories Home to import the movies with GPS location information to your computer.

## Computers

### Your computer does not recognize the camera.

- When the battery level is low, charge the camera.
- Turn on the camera and connect to a computer.
- Use the micro USB cable (supplied).
- Disconnect the micro USB cable (supplied) from both the computer and the camera, and connect it again firmly.
- Disconnect all equipment other than the camera, the keyboard and the mouse from the USB connectors of your computer.
- Connect the camera directly to your computer without passing through a USB hub or other device.

---

**Cannot import images.**

- Connect the camera and your computer correctly making a USB connection (page 64).

---

**PlayMemories Home cannot be installed.**

- Check the computer environment or installation procedure required to install PlayMemories Home.

---

**PlayMemories Home does not work correctly.**

- Quit PlayMemories Home and restart your computer.

---

**Cannot play back images on your computer.**

- Consult the computer or software manufacturer.

## Wi-Fi

**It takes too much time to transfer an image.**

- Microwave ovens or Bluetooth-enabled devices use the 2.4 GHz wavelength and could hinder the communication. If such devices are in the vicinity, move the camera away from those devices or shut those devices down.

## Others

**The lens gets fogged.**

- Moisture condensation has occurred. Turn off the camera and wait about an hour for the moisture to evaporate.

---

**The camera becomes warm when you use it for a long time.**

- This is not a malfunction.

---

**The date or time is incorrect.**

- Set the date and time again (page 18).

# Warning indicators and messages

If the following messages appear, follow the instructions.



- The battery level is low. Charge the battery pack immediately.

---

## ERROR

- Turn the power off and then on again.

---

## HEAT

- The camera temperature has risen. The power may turn off automatically, or you may be unable to record images. Leave the camera in a cool location until the temperature goes down.
- If you record images for an extended period, the camera temperature rises. In this case, stop recording images.

---

## NoIMG

- The memory card does not contain playable images.

---

## LowPw

- There is no remaining battery charge.

---

## BATT

- Battery charge is insufficient for operation.
- The battery pack is delivering current exceeding the maximum discharge current (beyond which proper operation of the camera cannot be assured when an external microphone, etc., is connected).
- A different battery pack is detected when the camera is powered on.
- Battery pack deterioration is detected.

---

## FULL

- Remaining capacity of the memory card is insufficient for recording.

---

## MAX

- The maximum number of files that can be recorded has been reached.

---

## MEDIA

- The memory card is not inserted properly.
- The memory card is damaged.
- The memory card format is incompatible with this camera.
- The memory card does not support XAVC S movie recording (page 17).

---

## NoCRD

- There is no memory card inserted.

---

## NoDSP

- The camera is not connected to a TV when playback is started.

---

## PLANE

- When the airplane mode is set to [ON], GPS and Wi-Fi cannot be used (page 37).

Table of  
contents

Operation  
Search

Settings  
Search

Index

# Recordable time

## Estimated duration of recording and playback for each battery pack

### Recording time

Approximate time available when you use a fully charged battery pack.

(Units: minutes)

Battery pack	Continuous recording time		Typical recording time	
Image quality	HQ	VGA	HQ	VGA
NP-BX1 (supplied)	120 (130)	140 (150)	60 (65)	85 (90)

- Times measured when using the camera at 25°C (77°F). It is recommended that you use the camera from 10°C to 30°C (50°F to 86°F).
- The recording and playback time will be shorter when you use the camera in low temperatures.
- The recording and playback time may be shorter, depending on the recording conditions.
- () indicates the recording time when the Wi-Fi remote control function is set to [OFF].

### Playing time

Approximate time available when you use a fully charged battery pack.

Approximate time when images are played back on a TV connected with a micro HDMI cable (sold separately).

(Units: minutes)

Battery pack	Playing time	
Image quality	HQ	VGA
NP-BX1 (supplied)	205	210

## Estimated recording time of movies

MP4 Average

(Units: minutes)

Image quality	8 GB	16 GB	32 GB	64 GB
PS	35	80	160	320
HS120/HS100/HS240/HS200	35	80	160	320
HQ	60	125	250	505
SSLOW	40	80	165	335
STD	160	320	650	1305
VGA	295	595	1200	2410

XAVC S Average

(Units: minutes)

Frame rate	64 GB
60p/50p/30p/25p/24p	155

- In the [SSLOW] setting, the above figure indicates the recordable time when shooting and differs from actual playback time.
- When using a Sony memory card.

Table of contents

Operation Search

Settings Search

Index



## Notes

- The recordable time may vary depending on the recording conditions, subjects, and the image quality setting (page 21).
- Continuous movie shooting time is approximately 13 hours.  
In [SSLOW] mode, it is approximately 3 hours.

## Estimated number of recordable photos

(unit: image)

	8 GB	16 GB	32 GB	64 GB
2M (Interval photo recording) (16:9)	7700	15500	31000	40000
13.5M (Still images)	1450	3000	6000	12000

- When using a Sony memory card.
- The number of recordable photos for the memory card shown is for the maximum image size for your camera. The actual number of recordable photos is displayed on the LCD screen during shooting.
- The number of recordable photos for a memory card may vary depending on the shooting conditions.

Table of contents

Operation Search

Settings Search

Index

# Battery pack

## On charging the battery pack

- Charge the battery pack before using the camera for the first time.
- We recommend charging the battery pack in an ambient temperature of between 10°C to 30°C (50°F to 86°F) until the REC/access/CHG (Charge) lamp turns off. The battery pack may not be effectively charged in temperatures outside this range.
- The REC/access/CHG (Charge) lamp may blink in the following situation:
  - Battery pack is not attached correctly.
  - Battery pack is damaged.
- When the battery pack temperature is low, detach the battery pack and place it in warm surroundings.
- When the battery pack temperature is high, detach the battery pack and place it in cool surroundings.

## Effective use of the battery pack

- Battery pack performance decreases in low temperature surroundings (less than 10°C (50°F)). So in cold places, the operational time of the battery pack is shorter. We recommend the following to ensure longer battery pack use: Put the battery pack in a pocket close to your body to warm it up, and insert it in the camera immediately before you start shooting.
- The battery pack will run out quickly if you use the playback, fast-forward, and fast-rewind frequently.
- Turn off the camera every time you do not shoot or playback on the camera. Battery pack is wearing out when the shooting is in standby.
- We recommend having spare battery packs handy for two times or three times the expected shooting time, and making trial shots before taking the actual shots.
- You may not be able to turn on the camera or the battery pack may not be effectively charged if the terminal section of the battery pack is dirty. In this case, wipe any dust with a soft cloth lightly to clean the battery pack.
- Do not expose the battery pack to water. The battery pack is not water-resistant.

## About the remaining battery charge

- If the battery pack runs out so fast although the remaining charge indicator is high, fully charge the battery pack again. Remaining charge indicator will be displayed correctly. Note that it may not be displayed correctly in the following situations:
  - Using the camera for a long time in high temperature
  - Leaving the camera with fully charged battery pack
  - Using a heavily used battery pack

## How to store the battery pack

- Fully discharge the battery pack before storing and store it in a cool, dry place. To maintain the battery pack's function, fully charge the battery pack and then fully discharge it on the camera at least once a year while storing.
- To prevent staining the terminal, short-circuiting, etc., be sure to use a plastic bag to keep away from metal materials when carrying or storing.

## On battery pack life

- The battery pack life is limited. Battery capacity decreases over time and through repeated use. If decreased usage time between charges becomes significant, it is probably time to replace it with a new one.
- The battery pack life varies according to how a battery pack is used.

# Using the camera abroad

## On TV color systems

To view images shot by the camera on a TV, you need a TV (or monitor) with an HDMI jack and a micro HDMI cable (sold separately).

Before shooting, be sure to set [V.SYS] to the TV system of the country and region where you will view recordings. The following shows which countries and regions you can view [NTSC] or [PAL] images.

## Countries and regions where you can view images when [V.SYS] is set to [NTSC]

Barbados, Bermuda, Bolivia, Canada, Chile, Columbia, Costa Rica, Cuba, Dominica, Ecuador, El Salvador, Guam, Guatemala, Guyana, Haiti, Honduras, Japan, Mexico, Micronesia, Myanmar, Nicaragua, Panama, Peru, Philippines, Puerto Rico, Republic of Korea, Saint Lucia, Samoa, Suriname, Taiwan, Trinidad and Tobago, United States of America, Venezuela etc.

## Countries and regions where you can view images when [V.SYS] is set to [PAL]

Australia, Austria, Argentina, Belgium, Bulgaria, Brazil, China, Croatia, Czech Republic, Denmark, Finland, France, French Guiana, Germany, Greece, Hong Kong, Hungary, Indonesia, Iran, Iraq, Italy, Kuwait, Malaysia, Monaco, Netherlands, New Zealand, Norway, Paraguay, Poland, Portugal, Romania, Russia, Singapore, Slovakia, Spain, Sweden, Switzerland, Thailand, Turkey, Ukraine, United Kingdom, Uruguay, Vietnam etc.

## World time difference

Time-zone differences	Area setting
GMT	Lisbon, London
+01:00	Berlin, Paris
+02:00	Helsinki, Cairo, Istanbul
+03:00	Nairobi
+03:30	Tehran
+04:00	Abu Dhabi, Baku, Moscow
+04:30	Kabul
+05:00	Karachi, Islamabad
+05:30	Kolkata, New Delhi
+06:00	Almaty, Dhaka
+06:30	Yangon
+07:00	Bangkok, Jakarta
+08:00	Hong Kong, Singapore, Beijing
+09:00	Seoul, Tokyo
+09:30	Adelaide, Darwin

Time-zone differences	Area setting
+10:00	Melbourne, Sydney
+11:00	Solomon Is
+12:00	Fiji, Wellington, Eniwetok, Kwajalein
-11:00	Samoa
-10:00	Hawaii
-9:00	Alaska
-8:00	Los Angeles, Tijuana
-7:00	Denver, Arizona
-6:00	Chicago, Mexico City
-5:00	New York, Bogota
-4:00	Santiago
-3:30	St.John's
-3:00	Brasilia, Montevideo
-2:00	Fernando de Noronha
-1:00	Azores, Cape Verde Is.

# Precautions

## Do not use/store the camera in the following places

- In an extremely hot, cold or humid place  
In places such as in a car parked in the sun, the camera body may become deformed and this may cause a malfunction.
- Under direct sunlight or near a heater are not suitable places for storage.  
The camera body may become discolored or deformed, and this may cause a malfunction.
- In a location subject to strong vibration
- Near strong magnetic fields
- In sandy or dusty places  
Be careful not to let sand or dust get into the camera. This may cause the camera to malfunction, and in some cases may be irreparable.

## On carrying

Do not sit down in a chair or other place with the camera in the back pocket of your trousers or skirt, as this may cause malfunction or damage the camera.

## Care and storage of the lens

- Wipe the surface of the lens clean with a soft cloth in the following instances:
  - When there are fingerprints on the lens surface.
  - In hot or humid locations
  - When the lens is exposed to salty air such as at the seaside.
- Store in a well-ventilated location subject to little dirt or dust.
- To prevent mold, periodically clean the lens as described above.

## On cleaning

Clean the camera surface with a soft cloth slightly moistened with water, then wipe the surface with a dry cloth. Do not use any of the following as they may damage the finish or the casing.

- Chemical products such as thinner, benzine, alcohol, disposable cloths, insect repellent, sunscreen or insecticide, etc.
- Do not touch the camera with any of the above on your hand.
- Do not leave the camera in contact with rubber or vinyl for a long time.

## On operating temperatures

The camera is designed for use in temperatures between  $-10^{\circ}\text{C}$  and  $40^{\circ}\text{C}$  ( $14^{\circ}\text{F}$  and  $104^{\circ}\text{F}$ ). Shooting in extremely cold or hot places that exceed this range is not recommended.

## On moisture condensation

If the camera is brought directly from a cold to a warm location, moisture may condense inside or outside the camera. This moisture condensation may cause a malfunction of the camera.

### If moisture condensation occurs

Turn off the camera and wait about 1 hour for the moisture to evaporate.

### Note on moisture condensation

Moisture may condense when you bring the camera from a cold place into a warm place (or vice versa) or when you use the camera in a humid place as shown below.

- When you bring the camera from a ski slope into a warm place.
- When you bring the camera from an air conditioned car or room into a hot place outside.
- When you use the camera after a squall or a shower.
- When you use the camera in a hot and humid place.

## How to avoid moisture condensation

When you bring the camera from a cold place into a warm place, put the camera in a plastic bag and seal it tightly. Remove the bag when the air temperature inside the plastic bag has reached the ambient temperature (after about 1 hour).

## Notes on optional accessories

- Genuine Sony accessories may not be available in some countries/regions.

## Note on disposal/transfer of the memory card

Even if you delete data in the memory card or format the memory card on the camera or a computer, you may not delete data from the memory card completely. When you give the memory card to somebody, it is recommended that you delete data completely using data deletion software on a computer. Also, when you dispose of the memory card, it is recommended that you destroy the actual body of the memory card.

## On GPS

- As the positions of GPS satellites vary constantly, it may take longer to determine the location or the receiver may not be able to determine the location at all, depending on the location and time you use the camera.
- GPS is a system that determines your position by receiving signals from satellites. Avoid using the GPS feature on your camera in places where radio signals are blocked or reflected, such as a shadowy place surrounded by buildings or trees, etc. Use the camera in open sky environments.
- You may not be able to record location information at locations or in situations where radio signals from the GPS satellites do not reach the camera as follows.
  - In tunnels, indoors or under the shade of buildings.
  - Between tall buildings or at narrow streets surrounded by buildings.
  - In underground locations, locations surrounded by dense trees, under an elevated bridge, or in locations where magnetic fields are generated, such as near high voltage cables.
  - Near devices that generate radio signals of the same frequency band as the camera: near 1.5 GHz band mobile telephones, etc.
- If you take images with the GPS log set to [ON], and upload those images to the Internet, the shooting location may be available to third parties. To prevent this, set GPS log to [OFF] before shooting.

## On triangulation errors

- If you move to another location right after turning the camera on, it may take a longer time for the camera to start triangulating, compared to when you stay in the same place.
- Error caused by the position of GPS satellites  
The camera automatically triangulates your current location when the camera receives radio signals from 3 or more GPS satellites. The triangulating error allowed by the GPS satellites is about 10 m (33 feet). Depending on the environment of the location, the triangulating error can be greater. In this case, your actual location may not match the location on the map based on the GPS information. Meanwhile, the GPS satellites are controlled by the United States Department of Defense, and the degree of accuracy may be changed intentionally.
- Error during the triangulating process  
The camera acquires location information periodically during triangulating. There is a slight time lag between when the location information is acquired and when the location information is recorded on an image, therefore, the actual recording location may not match the exact location on the map based on the GPS information.

## On GPS use restriction

- Use GPS in accordance with the situation and regulations of the countries/regions where you use the camera.

# Specifications

## Camera

### [System]

#### Video signal

- NTSC color, EIA standards
- HDTV 1080/60i, 1080/60p specification
- PAL color, CCIR standards
- HDTV 1080/50i, 1080/50p specification

#### Image device:

- 7.76 mm (1/2.3 type)
- Exmor R™ CMOS sensor

#### Recording pixels (16:9):

- Interval photo recording mode:
  - Max. 2 000 000 pixels equivalent
  - Photo mode: Max 13 500 000 pixels equivalent

#### Gross: Approx. 18 900 000 pixels

#### Effective (movie, 16:9):

- Approx. 13 500 000 pixels

#### Effective (still, 16:9): Approx. 13 500 000 pixels

#### Lens: ZEISS Tessar Lens

- F2.8
- f = 2.8 mm (1/9 in.)
- When converted to a 35 mm still camera
- For movies: 17.1 mm (11/16 in.) (16:9)\*

#### Exposure control: Automatic exposure

#### File format:

- Still images: JPEG (DCF Ver. 2.0, Exif Ver. 2.3, MPF Baseline) compliant
- Movies: MP4: MPEG-4 AVC/H.264, XAVC S: MPEG-4 AVC/H.264
- Audio: MPEG AAC (When recording MP4 movies), LPCM (When recording XAVC S movies)

#### Recording media:

- When recording MP4 movies:
  - Memory Stick Micro (Mark2) media
  - microSD card (Class4 or faster)
- When recording XAVC S movies:
  - microSD card (Class10 or faster)

#### Minimum illumination: 6 lx (lux)

\* SteadyShot set to [OFF]

### [Input and Output connectors]

HDMI OUT jack: HDMI micro connector

USB jack: Multi/Micro USB Terminal\*: micro-B/USB2.0 Hi-Speed (mass-storage)

\* Supports Micro USB compatible devices.

Mic jack (stereo)

- USB connection is only for output. (For customers in Europe)

### [Power, general]

#### Power requirements:

Rechargeable battery pack: 3.6 V (NP-BX1 (supplied))

Multi/Micro USB Terminal: 5.0 V

USB charging: DC 5.0 V, 500 mA/800 mA

#### Charging time:

##### Via a computer

NP-BX1 (supplied): Approx. 245 min

##### Via the AC-UD20 (sold separately)

NP-BX1 (supplied): Approx. 175 min

Power consumption: 1.9 W (when the movie image size is [1920×1080/30p])

Operating temperature: -10°C to +40°C (14°F to 104°F)

Storage temperature: -20°C to +60°C (-4°F to +140°F)

Dimensions: Approx. 24.2 mm × 46.5 mm × 81.5 mm (31/32 in. × 1 7/8 in. × 3 1/4 in.) (W/H/D, excluding protrusions)

Mass: Approx. 67 g (2.4 oz) (camera only)

#### Mass (when shooting):

Approx. 92 g (3.2 oz) (including NP-BX1 (supplied))

Microphone: Stereo

Speaker: Monaural

Rechargeable battery pack:

NP-BX1 (supplied)

Maximum output voltage: DC 4.2 V

Output voltage: DC 3.6 V

Capacity (minimum): 4.5 Wh (1 240 mAh)

Type: Li-ion

### [Wireless LAN]

Corresponding standard: IEEE 802.11b/g/n

Frequency: 2.4 GHz

Supported security protocols: WPA-PSK/WPA2-PSK

Configuration method: WPS (Wi-Fi Protected Setup)

Access method: Infrastructure Mode

NFC: NFC Forum Type 3 Tag compliant

### [Accessories]

#### Tripod Adaptor

Dimensions: Approx. 23.0 mm × 14.0 mm × 48.7 mm (29/32 in. × 9/16 in. × 1 15/16 in.) (W/H/D, excluding protrusions)

Mass: Approx. 12 g (0.4 oz)

Table of contents

Operation Search

Settings Search

Index

### Waterproof Case (SPK-AS2)

Dimensions: Approx. 35.5 mm × 62.0 mm × 96.0 mm (1 7/16 in. × 2 1/2 in. × 3 7/8 in.) (W/H/D, excluding protrusions)

Mass: Approx. 55 g (1.9 oz)

Pressure-resistance: Shooting underwater at a depth of 5 m (16 feet) for 30 continuous minutes is possible. \*

\*When the camera is inserted.

### Adhesive Mount (VCT-AM1)

#### Attachment Buckle

Dimensions: Approx. 43.5 mm × 14.0 mm × 58.5 mm (1 3/4 in. × 9/16 in. × 2 3/8 in.) (W/H/D, excluding protrusions)

Mass: Approx. 15 g (0.5 oz)

#### Flat Adhesive Mount

Dimensions: Approx. 50.0 mm × 12.5 mm × 58.5 mm (2 in. × 1/2 in. × 2 3/8 in.) (W/H/D, excluding protrusions)

Mass: Approx. 14 g (0.5 oz)

#### Curved Adhesive Mount

Dimensions: Approx. 50.0 mm × 16.0 mm × 58.5 mm (2 in. × 21/32 in. × 2 3/8 in.) (W/H/D, excluding protrusions)

Mass: Approx. 16 g (0.6 oz)

Design and specifications are subject to change without notice.

Table of contents

Operation Search

Settings Search

Index

## Trademarks

- Memory Stick and  are trademarks or registered trademarks of Sony Corporation.
- The terms HDMI and HDMI High-Definition Multimedia Interface, and the HDMI Logo are trademarks or registered trademarks of HDMI Licensing LLC in the United States and other countries.
- Microsoft, Windows and Windows Vista are either registered trademarks or trademarks of Microsoft Corporation in the United States and/or other countries.
- Mac is a registered trademark of Apple Inc. in the United States and other countries.
- Intel, Pentium and Intel Core are trademarks of Intel Corporation in the U.S. and/or other countries.
- Adobe, the Adobe logo, and Adobe Acrobat are either registered trademarks or trademarks of Adobe Systems Incorporated in the United States and/or other countries.
- microSDXC logo is a trademark of SD-3C, LLC.
- The N Mark is a trademark or registered trademark of NFC Forum, Inc. in the United States and in other countries.
- iPhone and iPad are trademarks of Apple Inc., registered in the U.S. and other countries.
- iOS is a registered trademark or trademark of Cisco Systems, Inc.
- Android and Google Play are trademarks of Google Inc.
- Wi-Fi, the Wi-Fi logo and Wi-Fi PROTECTED SET-UP are registered trademarks of the Wi-Fi Alliance.
- “PS” and “PlayStation” are registered trademarks of Sony Computer Entertainment Inc.



- Add further enjoyment with your PlayStation 3 by downloading the application for PlayStation 3 from PlayStation Store (where available.)
- The application for PlayStation 3 requires PlayStation Network account and application download. Accessible in areas where the PlayStation Store is available.

In addition, system and product names used in this manual are, in general, trademarks or registered trademarks of their respective developers or manufacturers. However, the <sup>TM</sup> or © marks may not be described in this manual.



## On GNU GPL/LGPL applied software

The software that is eligible for the following GNU General Public License (hereinafter referred to as “GPL”) or GNU Lesser General Public License (hereinafter referred to as “LGPL”) are included in the camera.

This informs you that you have a right to have access to, modify, and redistribute source code for these software programs under the conditions of the supplied GPL/LGPL.

Source code is provided on the web. Use the following URL to download it. When downloading the source code, select HDR-AS100V as the model for your camera.

<http://www.sony.net/Products/Linux/>

We would prefer you do not contact us about the contents of source code.

Copies of the licenses (in English) are stored in the internal memory of your camera.

Establish a Mass Storage connection between your camera and a computer, and read the files in the “LICENSE” folder in “PMHOME.”



# Index

## A

A.OFF.....	39
Airplane mode.....	37
Auto power off.....	39

## B

Battery pack.....	74
BEEP.....	40
Beep.....	40

## C

Charging.....	14
COLOR.....	27
Color Setting.....	27
CONFIG.....	32
Configuration settings.....	32
Copy.....	34

## D

DATE.....	18
Date & Time Setting.....	18
Daylight Saving Time (Summer Time) Setting.....	20
DST.....	20

## E

ENTER (Menu execute) button.....	10
----------------------------------	----

## F

FLIP.....	24
Flip.....	24
Format.....	44
FORMT.....	44

## G

GPS.....	35
GPS Log.....	35

## H

HDMI OUT jack.....	54
--------------------	----

## I

Identifying parts.....	11
Image quality setting mode.....	21

Interval photo recording.....	26
Interval photo recording mode.....	52
INTVL.....	52
IR-RC.....	31
IR-Remote controller.....	31

## L

LANG.....	41
Language setting.....	41
LAPSE.....	26
Live-View Remote.....	61

## M

MOVIE.....	52
Multi/Micro USB Terminal.....	64

## N

NEXT button.....	10
NFC.....	57
Number of recordable photos.....	73

## P

PHOTO.....	52
PLANE.....	37
PLAY.....	54
PREV button.....	10
PRO.....	28

## R

REC button.....	52
REC HOLD (lock) switch.....	52
REC/access/CHG (Charge) lamp.....	14, 52
Recordable time of movies.....	72
RESET.....	43
Resetting the settings.....	43

## S

SCENE.....	25
Scene.....	25
Settings.....	9
Shooting	
Movies.....	52
Still image.....	52
Smartphone.....	56, 57

SteadyShot.....	23
STEDY.....	23
Switching NTSC/PAL.....	42

## T

TC/UB.....	29
Time code/user bit.....	29
Troubleshooting.....	66

## U

USB.....	14
USB power supply.....	38
USBPw.....	38

## V

V.SYS.....	42
Viewing	
Movies.....	54
Still image.....	54
VMODE.....	21

## W

Warning messages.....	70
Wi-Fi.....	57
Wi-Fi remote control.....	33

## X

XAVC S.....	28
-------------	----

Table of  
contents

Operation  
Search

Settings  
Search

Index